

# Data Sheet for Product

Part Number: WM72T2F-YR06B-S



The Component corresponds with display's hazardous substance management standard and complies with  RoHS and  Halogen free.

---

**WOOREE** E&L Co.,Ltd.

636-3, Sunggok-dong, Danwon-gu, Ansan-si, Kyunggy-do, Korea. Tel (031)599-3013 Fax (031)494-3174

# CONTENTS

1. Features
2. Outline Dimension
3. Material Information
4. Absolute Maximum Ratings
5. Electrical / Optical Characteristics
6. Ranks
7. Characteristic Diagrams
8. Reliability
9. Packing
10. Precaution to taken

## 1. Features

- SMD Top View Type with Lead Frame Base
- Long Time Reliability
- Package size is 7.0 \* 2.0\* 0.8t (mm), 2Lead
- Application : MNT BLU

## 2. Outline Dimension

UNIT : mm

Tolerance :  $\pm 0.05$

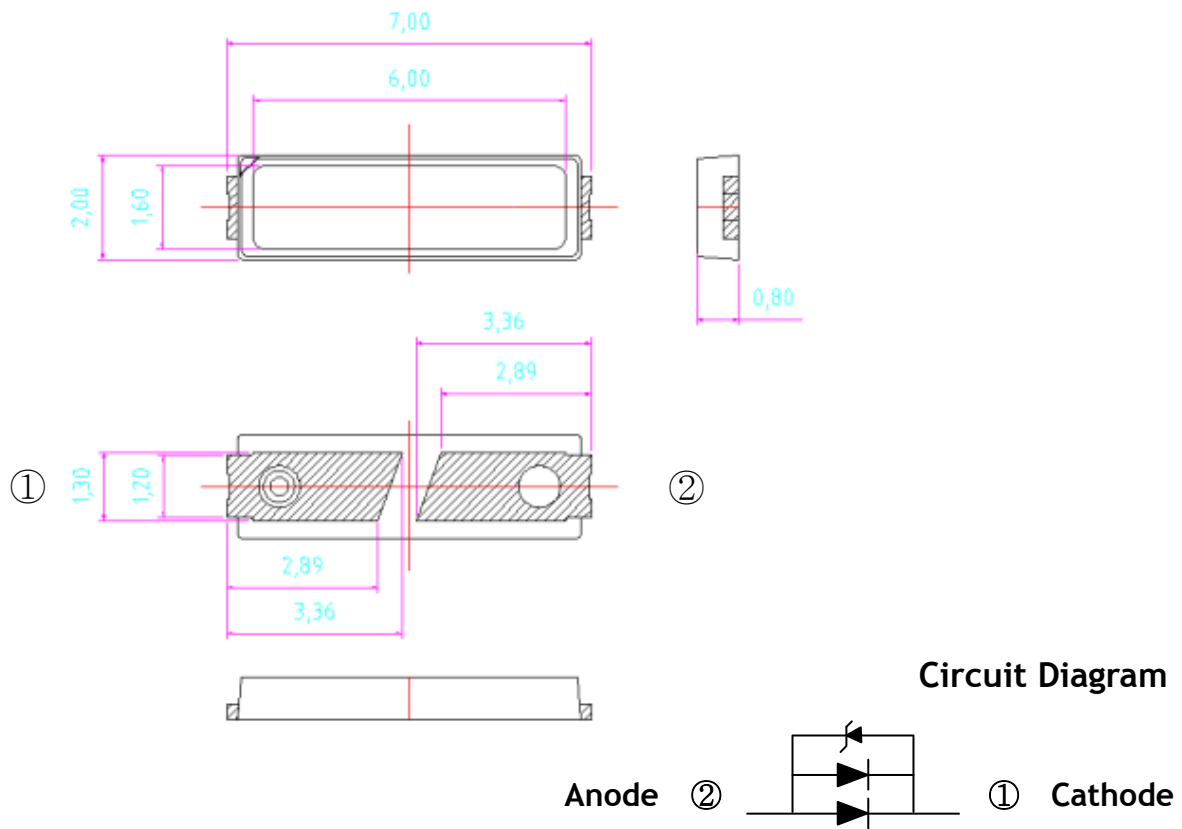

### 3. Material Information

Item	Chip		Paste		Leadframe		Phosphor	Encap	Wire
	LED	Zener	LED	Zener	Reflector	Metal			
Material	InGaN	Si	Clear Paste	Ag Paste	PCT	Ag plated /Cu	Nitride	Silicone	Au

### 4. Absolute maximum ratings

(Ta=25°C)

Item	Symbol	Absolute Maximum Ratings	Unit
Forward Current	IF	150	mA
Power Dissipation	PD	0.5	W
Reverse Current	IR	50	mA
Pulse Forward Current *1	I <sub>FP*1</sub>	250	mA
Operating Temperature	Topr	-40 ~ +85	°C
Storage Temperature	Tstg	-40 ~ +100	°C
Solder Temperature	Tsld	Reflow 260 °C,10sec under Hand 340 °C 3sec under	°C
ESD	HBM	5	KV
Junction Temperature	Tj	110	°C

\*1. Pulse Width ≤ 10msec, Duty ≤ 10%

## 5. Electrical/Optical characteristics

(Ta=25°C)

Item	Symbol	Condition	Value			Unit	
			Min	Typ	Max		
Luminous Flux *1	Iv	IF=120mA	36.0	38.0	40.0	lm	
Forward Voltage *2	VF	IF=120mA	2.9	3.1	3.3	V	
Forward Voltage	VFL	IF=1uA	2.0		2.5		
Forward Voltage	VFL	IF=10uA	2.2	-	2.55	V	
Chromaticity Coordinate *3	-	IF=120mA	x	0.250	0.295	0.313	-
			y	0.224	0.275	0.296	-
Reverse Voltage	VR	IR=-5mA	-0.7		-1.2	V	
Viewing Angle	2Θ1/2	IF=120mA	-	120	-	Deg.	
Thermal Resistance (Junction to Lead)	Rth,j-s	IF=120mA		14		K/W	
Life Time*4	-	Tj max. 80°C	30,000	-	-	hr	
Peak Wavelength	Wp	IF=120mA	438		450	nm	

\*1. Luminous Intensity(Flux) measurement allowance is ±5%

\*2. Forward voltage measurement : ±0.05V

\*3. CIE coordinates measurement: ±0.005

\*4. Estimated Time to 50% degradation for initial luminous intensity based on WOOREE LED's Internal test results.

※Life time : L50B1 (Min Life time)

## 6. Ranks

### (1) Luminous Intensity

Code	Condition	Luminous Intensity [cd]	Luminous Flux [lm]
D2	IF = 120mA	13.2-13.6	36.0~37.0
D6		13.6~13.9	37.0~38.0
D9		13.9~14.3	38.0~39.0
E3		14.3~14.7	39.0~40.0
E7		14.7~15.0	40.0~41.0

### (2) Forward Voltage

Code	Condition	Min.	Max.	Unit
9	IF = 120mA	2.9	3.1	V
1		3.1	3.3	

### (3) Peak Wavelength

Code	Condition	Min.	Max.	Unit
A	IF = 120mA	438.0	441.0	nm
B		441.0	447.0	
C		447.0	450.0	

#### (4) Chromaticity Coordinates Diagram

IF=120mA (Ta = 25°C)

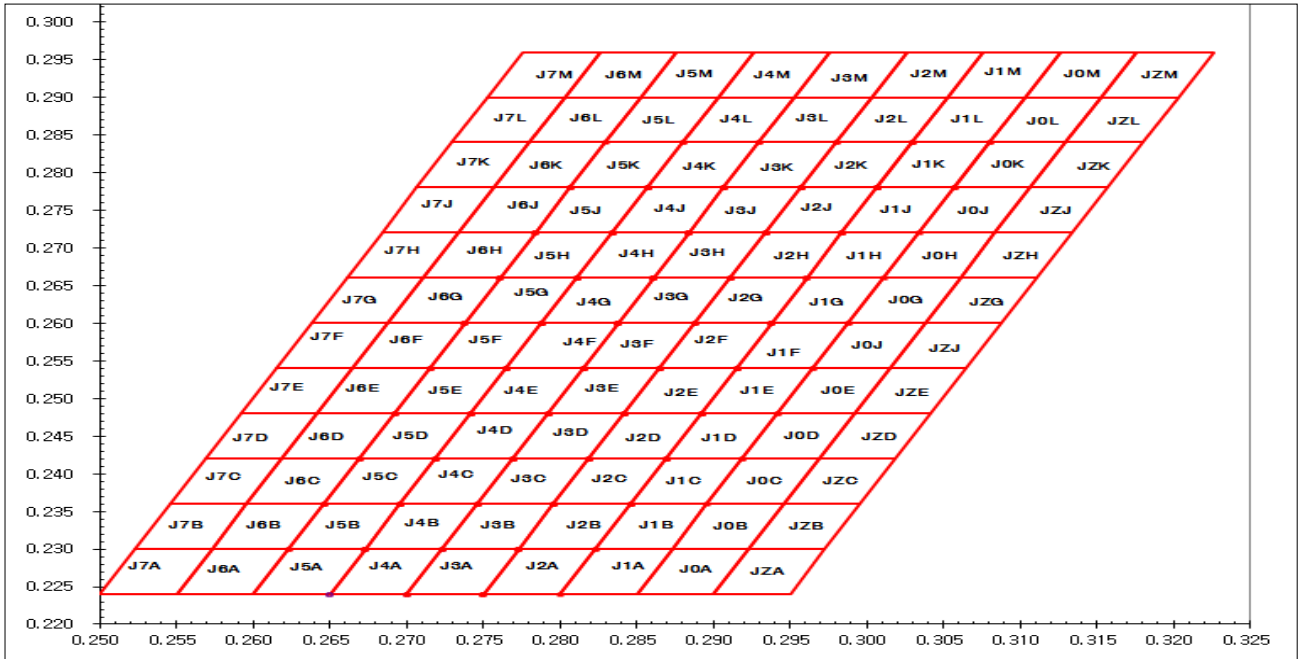

#### (5) Color spectrum

IF=120mA (Ta = 25°C)

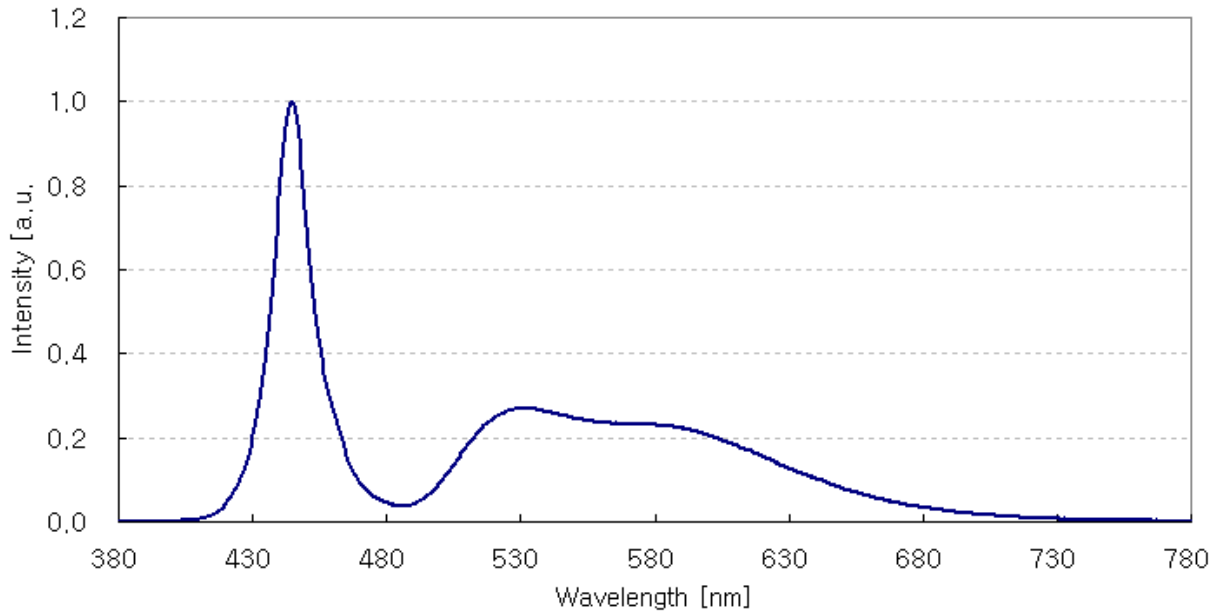

# 7. Characteristic Diagrams

(1) Forward Voltage vs Forward Current

(Ta = 25°C)

Current vs. Voltage

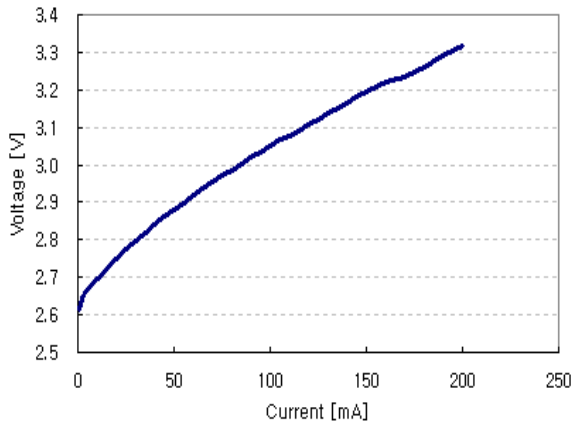

(2) Relative Luminosity vs Forward Current

(Ta = 25°C)

Current vs. L-Flux

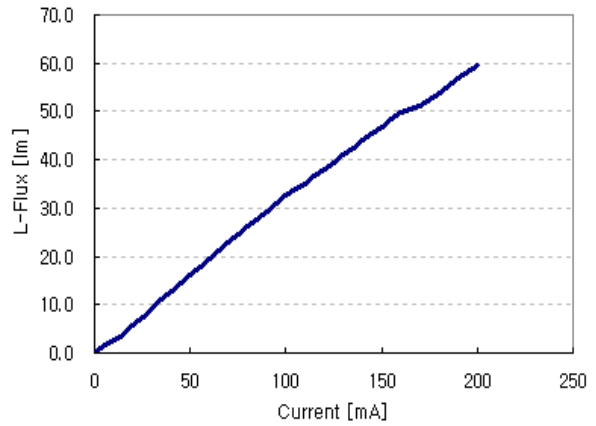

(3) Ambient Temperature vs Allowable Forward Current

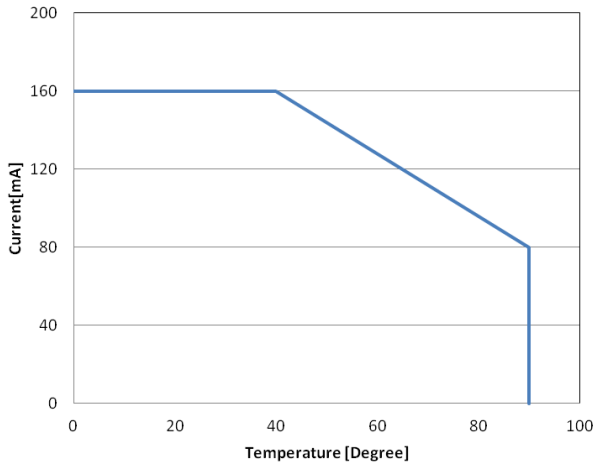

(4) Ambient Temperature vs Relative Luminous Flux

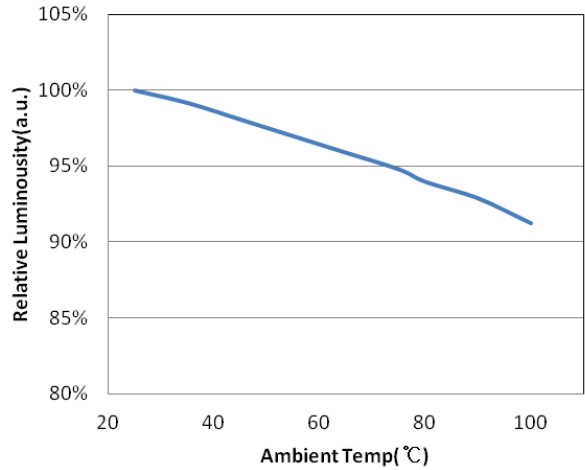



(5) Forward Current vs. Chromaticity Coordinate (Temp: 25°C)

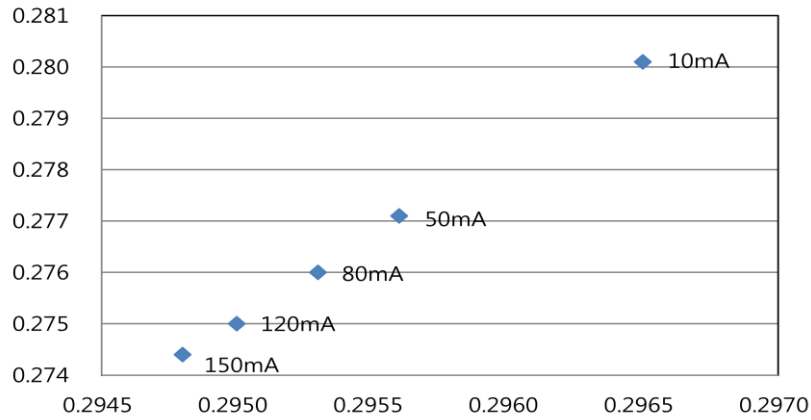

(6) View angle profile

IF= 120mA (Temp: 25°C)

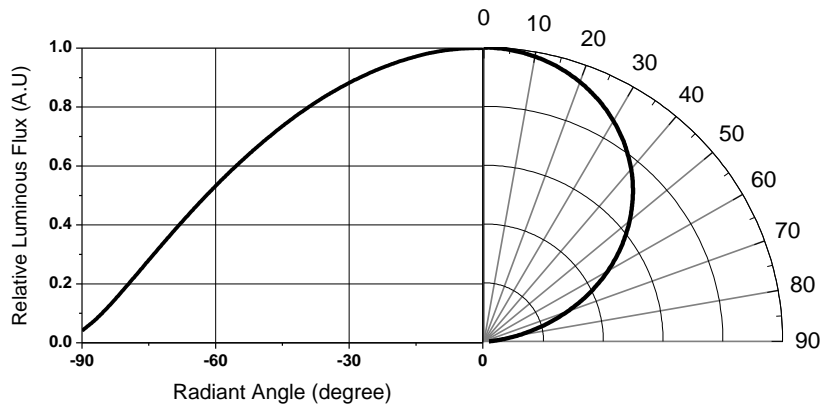

## 8. Reliability

### (1) Test items and results

NO	Test Item	Standard Test Method	Test Conditions	Note	Number of Damaged
1.	Resistance to Soldering Heat (Reflow Soldering)	JEITA ED-4701 300 301	Tsld=260°C, 10sec. (Pre treatment 30°C,70%,168hrs)	2 times	0/20
2	Solderability (Reflow Soldering)	JEITA ED-4701 300 303	Tsld=245±5°C, 3sec (Lead Solder)	over 95%	0/20
3	Temperature Cycle	JEITA ED-4701 100 105	-40°C~100°C 30min~30min	200 cycles	0/20
4	High Temperature Storage	JEITA ED-4701 200 201	Ta=100°C	1000 hrs	0/20
5	Temperature Humidity Storage	JEITA ED-4701 100 103	Ta=85°C, RH=85%	1000 hrs	0/20
6	Low Temperature Storage	JEITA ED-4701 200 202	Ta=-40°C	1000 hrs	0/20
7	Steady State Operating Life	-	Ta=25°C, IF=150mA	1000 hrs	0/20
8	Steady State Operating Life of High Temperature	-	Ta=85°C, IF=150mA	1000 hrs	0/20
9	Steady State Operating Life of High Humidity Heat	-	Ta=85°C, RH=85%, IF=150mA	1000 hrs	0/20
10	Steady State Operating Life of Low Temperature	-	Ta=-40°C, IF=150mA	1000 hrs	0/20
11	On-Off Operating Test		50C, 95%RH, IF=150mA, On-Off each 2sec	108K Cycle	0/10
12	Moisture Resistance Cycle		-10C ↔ 25C/90%RH ↔ 65C/90%RH [24hrs/1cycle]	10times	0/10
13	Electro-Static Discharge Threshold	ESD (HBM)	1500Ω, 100pF (Forward)	5000V	0/10
			1500Ω, 100pF (Reverse)	5000V	0/10

**(2) Criteria for judging the damage**

\*Ini. = Initial Value

ITEM	Symbol	Test Condition	Criteria for Judgement	
			Min.	Max.
Forward Voltage	VF	IF = 150mA	-	Ini. X 1.1
Luminous Intensity	Iv	IF = 150mA	Ini. x 0.7	-
White Color	Cx	IF = 150mA	Ini. ±0.03	-
	Cy		Ini. ±0.03	-

**(3) Silicone Depth Judgement**

**Silicone Depth Spec**

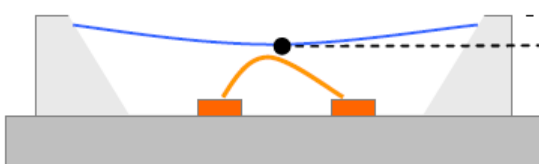

- Silicone Depth = A ~ B  
A : Mold 상단면  
B : 봉지재 면 (PKG 중심부)

**• LED PKG Silicone Depth Spec.**

1. 상온 (25°C)에서 Silicone Depth > 30um 일 것
2. Wire는 봉지재 위로 노출 없을 것

**Silicone Depth Spec 불량**

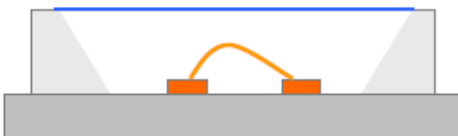

- LED PKG Silicone Depth = 0 um (Flat) 으로 불량 임.

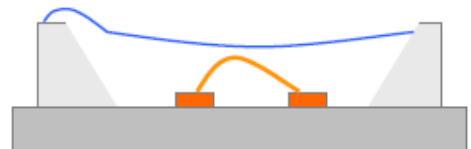

- 봉지재가 Mold 상단면을 표정으로 불량 임.

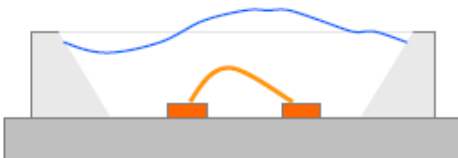

- 봉지재의 중심 또는 일부가 Mold 상단면 보다 돌출 되었으므로 불량 임.

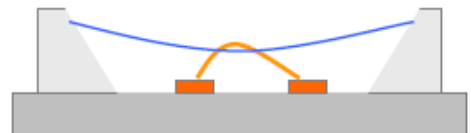

- Wire가 봉지재 위로 노출되어 불량 임.

# 9. Packing

## (1) Taping part

unit : mm  
tolerance : ± 0.1

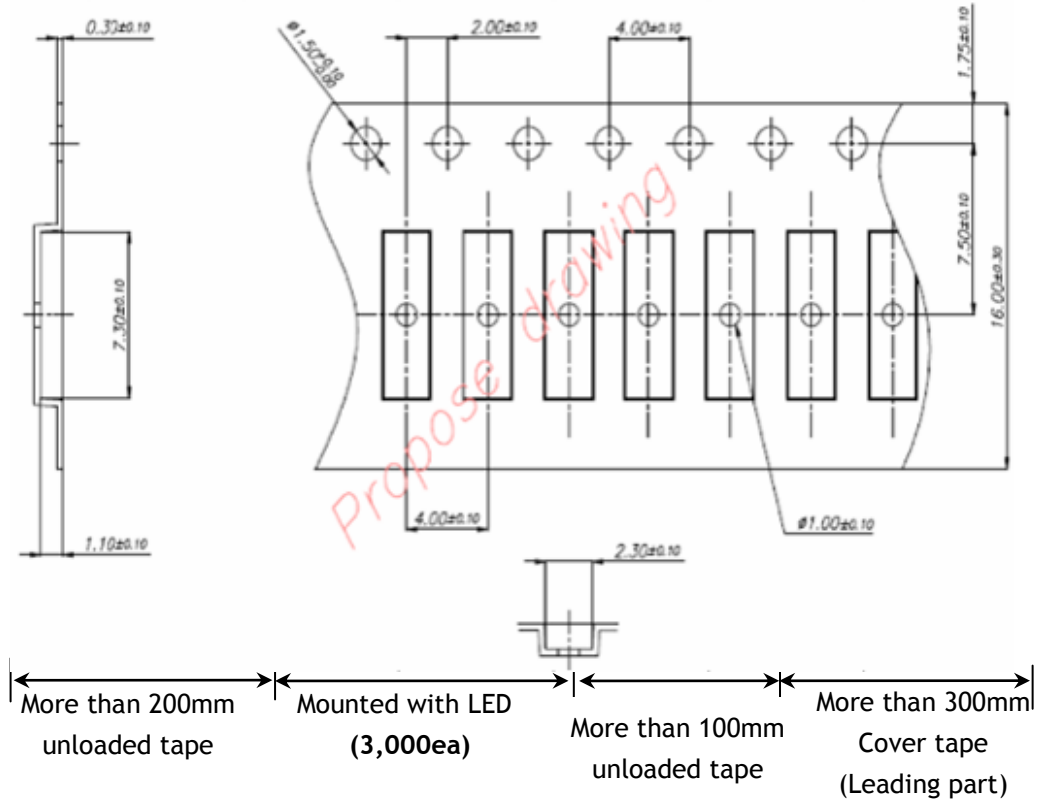

## (2) Reel part (Q'ty : 3,000ea/Reel)

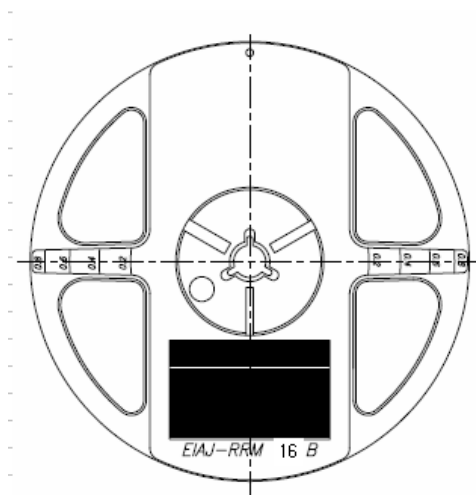

LABEL

### (3) Boxing

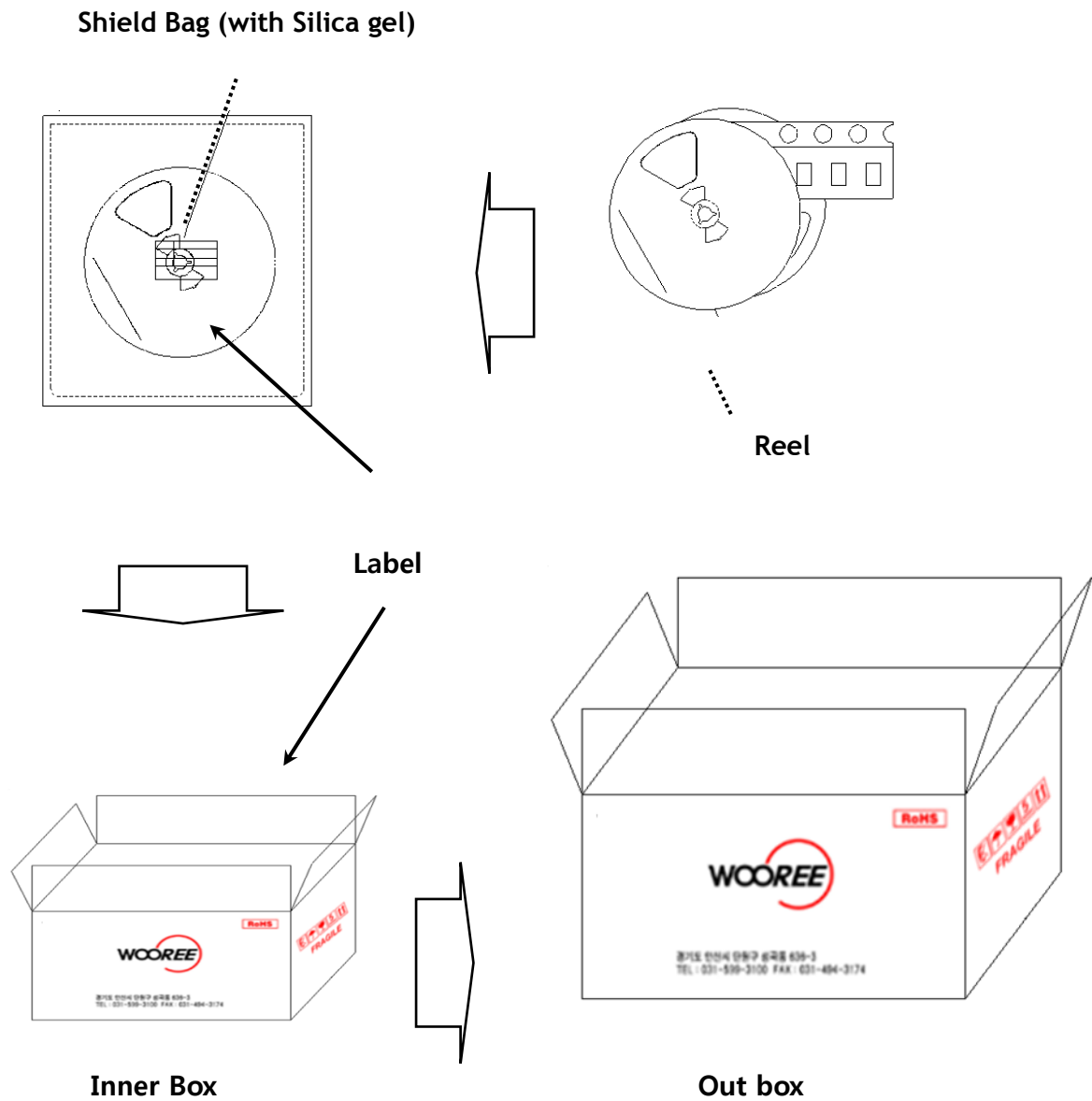

Box	Dimension (mm)	Reel/Box	Quantity/Box
Inner box	500*260*250	24 Reel max.	72,000 ea
Out box	555*515*540	96 Reel max.	288,000 ea

#### (4) Label Information

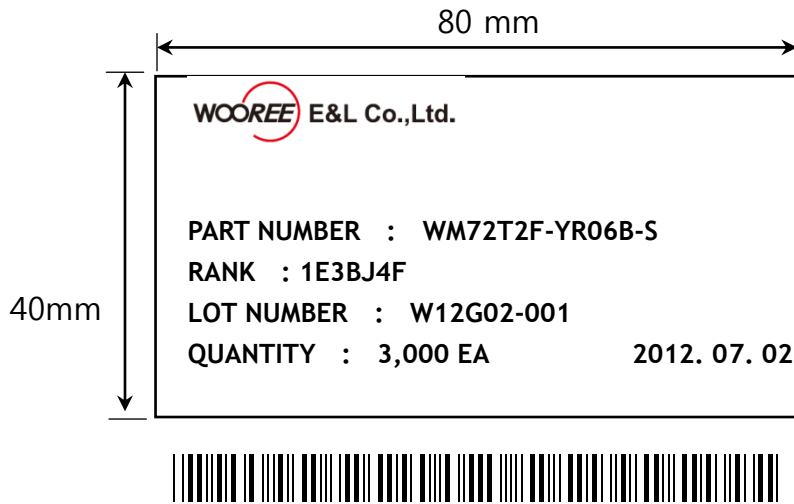

#### (5) Lot Number



- ①      ②      ③      ④                      ⑤
- ① WOOREE LED Initial
  - ② Year (12 for 2012, 13 for 2013)
  - ③ Month (A for Jan., B for Feb., ... , N for Dec.)
  - ④ Day (01 for 1,...31 for 31)
  - ⑤ WOOREE LED Product Running Number

#### (6) Rank Code description

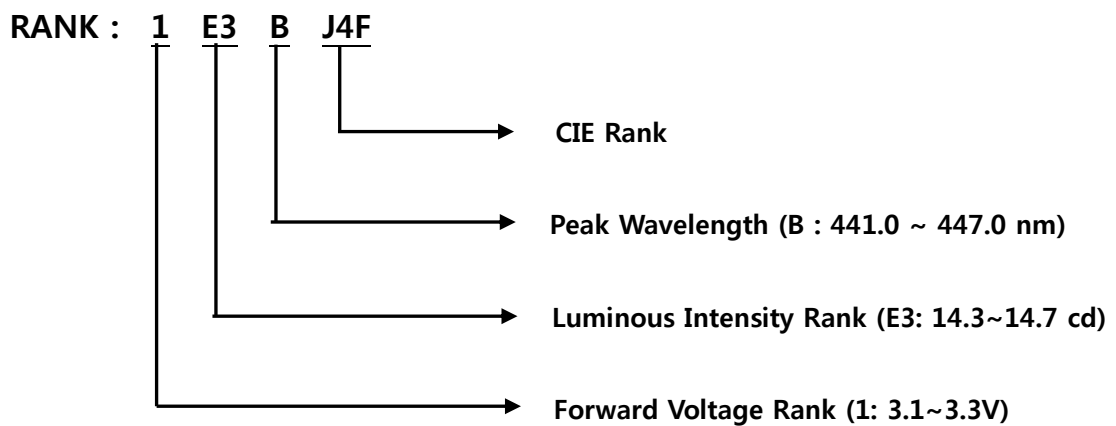

# 10. Precautions to taken

## Recommend soldering conditions

Reflow Soldering			Hand Soldering(Lead Part)	
	Lead Solder	Lead Free Solder	Temperature Soldering Time	Max. 340°C Max. 3sec (only one time)
Pre-heat	120~150°C	180~200°C		
Pre-heat time	120sec	120sec. Max.		
Peak temperature	Max. 240°C	Max. 260°C		
Soldering Time	Max. 10sec	Max. 10sec		
Condition				

### Temperature-profile

#### <Lead Solder>

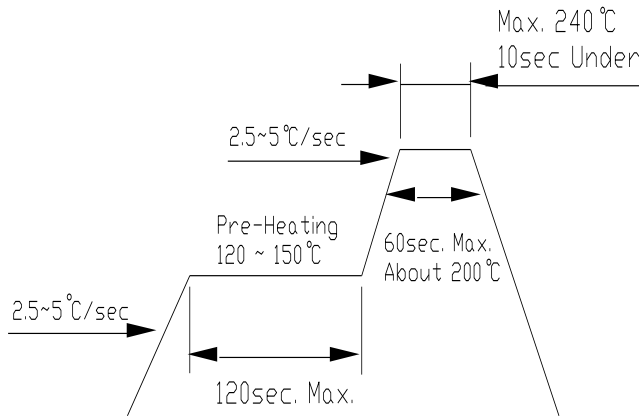

#### <Lead-free Solder>

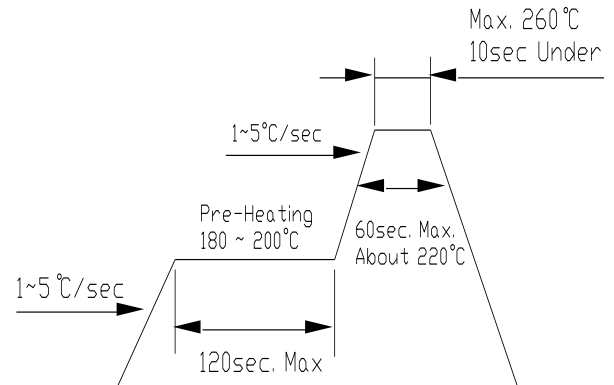

### <Recommended soldering pad design>

Unit: mm

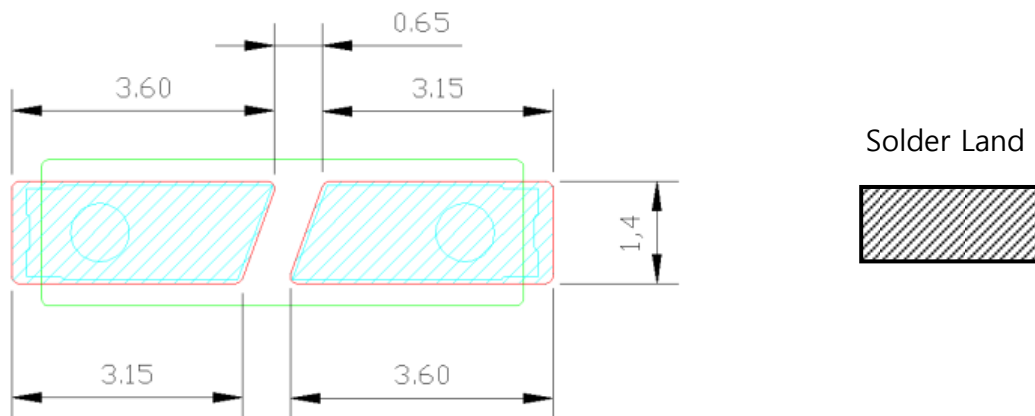

## **(2)Moisture Proof Package**

When moisture is absorbed into the SMT package it may vaporize and expand during soldering. There is a possibility that this can cause exfoliation of the contacts and damage to the optical characteristics of the LEDs. For this reason, the moisture proof package is used to keep moisture to a minimum in the package. The moisture proof package is made of an aluminum moisture proof bag. A package of a moisture absorbent material(silica gel) is inserted into the aluminum moisture proof bag. The silica gel changes its color from blue to pink as it absorbs moisture.

## **(3)Storage**

[Storage conditions]

Before opening the package

The LEDs should be kept at 30°C or less and 90% RH or less. The LEDs should be used within a year. When storing the LEDs, moisture proof packaging with absorbent material(silica gel) is recommended.

After opening the package

The LEDs should be kept at 30°C or less and 70% RH or less. The LEDs should be soldered within 168 hours(7days) after opening the package. If unused LEDs remain, they should be stored in moisture proof packages, such as sealed containers with package of moisture absorbent material(silica gel). It is also recommended to return the LEDs to the original moisture proof bag and to reseal the moisture proof bag again.

If the moisture absorbent material(silica gel) has faded away or the LEDs have exceeded the storage time, baking treatment should be performed using the following conditions.

Baking treatment : more than 24hours at 65±5°C

WOOREE LED part's electrodes and leadframes are silver plated copper alloy.

The silver surface may be affected by environments which contain corrosive



substances.

Please avoid conditions which may cause the LED to corrode, tarnish or discolor. The corrosion or discoloration might lower solderability or might affect on optical Characteristics.

Please avoid rapid transitions in ambient temperature, especially in high humidity environments where condensation can occur.

#### **(4)Heat Generation**

Thermal design of the end product is of paramount importance. Please consider the heat generation of the LED when making the system design. The coefficient of temperature increase per input electric power is affected by the thermal resistance of the circuit board and density of LED placement on the board, as well as other components. It is necessary to avoid intense heat generation and operate within the maximum ratings given in the specification.

The operating current should be decided after considering the ambient maximum temperature of LEDs.

#### **(5) Handling Precautions**

When handling the product, touching encapsulant with bare hands will contaminate its surface that could affects on optical characteristics. In the worst cases, excessive force to the encapsulant by hand might result in catastrophic failure of the LEDs due to wire deformation and/or breakage.