

# Data Sheet for Product

---

Part Number : WM73T2F-YR03B-RA



The Component corresponds with display's hazardous substance management standard and complies with  RoHS and  Halogen free.

---

**WOOREE** E&L Co.,Ltd.

636-3, Sunggok-dong, Danwon-gu, Ansan-si, Kyunggy-do, Korea. Tel (031)599-3013 Fax (031)494-3174

# CONTENTS

- 1. Features**
- 2. Outline Dimension**
- 3. Material Information**
- 4. Absolute Maximum Ratings**
- 5. Electrical / Optical Characteristics**
- 6. Rank Information**
- 7. Characteristic Diagrams**
- 8. Reliability**
- 9. Soldering Information**
- 10. Packaging & Label**

# 1. Features

- SMD Top View Type with Lead Frame Base
- Long Time Reliability
- Package size is 7.0 \* 3.0\* 0.8t (mm), 2Lead
- Application : TV BLU

# 2. Outline Dimension

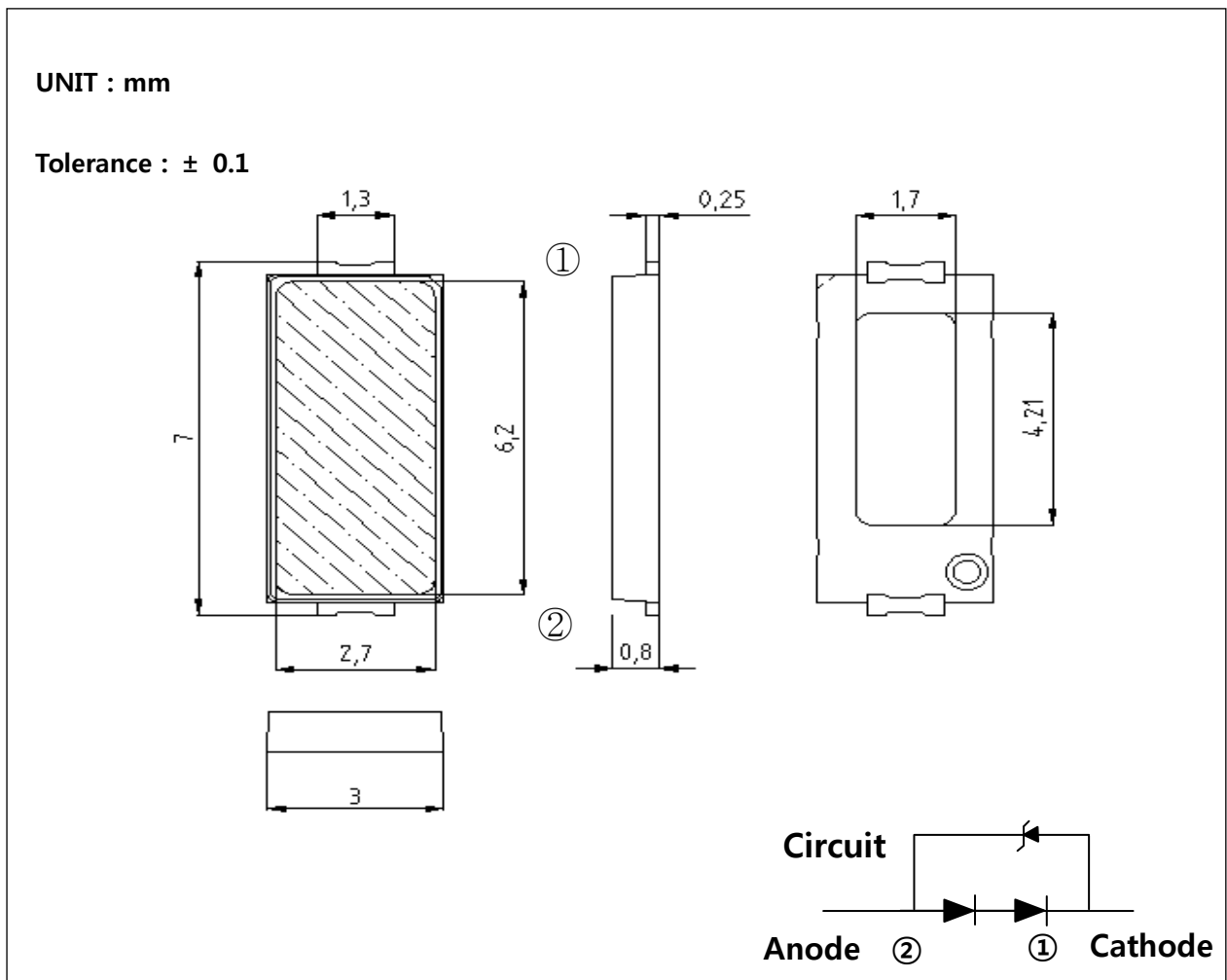

### 3. Material Information

Item	Chip		Paste		Leadframe		Phosphor	Encap	Wire
	LED	Zener	LED	Zener	Reflector	Metal			
Material	InGaN	Si	Clear Paste	Ag Paste	PCT	Ag plated /Cu	Nitride	Silicone	Au

### 4. Absolute maximum ratings

(Ta=25°C)

Item	Symbol	Absolute Maximum Ratings	Unit
Forward Current	IF	240	mA
Power Dissipation	PD	0.8	W
Reverse Current	IR	50	mA
Pulse Forward Current *1	I <sub>FP*1</sub>	300	mA
Operating Temperature	Topr	-30 ~ +85	°C
Storage Temperature	Tstg	-40 ~ +100	°C
Solder Temperature	Tsld	Reflow 260°C 10sec under Hand 340°C 3sec under	°C
Junction Temperature	Tj	125	°C

\*1. Pulse Width ≤ 10msec, Duty ≤ 10%

## 5. Electrical/Optical characteristics

(Ta=25°C)

Item	Symbol	Condition	Value			Unit
			Min	Typ	Max	
Luminous Intensity *1	Cd	IF=93mA	17	20	23	cd
Forward Voltage *2	VF	IF=93mA	6.0	6.4	6.8	V
Forward Voltage	VFL	IF=10uA	4.0	-	-	V
Chromaticity	X	IF=93mA		0.262		
Coordinate *3	Y			0.218		
Reverse Voltage	VR	IR=-5mA	-0.7		-1.2	V
Viewing Angle	2Θ1/2	IF=93mA	-	120	-	Deg.
Electro-Static Discharge	ESD	HBM	5000			V
Life Time*4	-	Tj max. 95°C	30,000		-	hr
Thermal Resistance	Rth	IF = 93mA		12.6		°C/w
Peak Wavelength	Wp	-	435.5		451.5	nm

\*1. Luminous Intensity(Flux) measurement allowance is ±10%

\*2. Forward voltage measurement : ±0.1V

\*3. CIE coordinates measurement: ±0.005

\*4. Estimated Time to 50% degradation for initial luminous intensity based on WOOREE LED's Internal test results.

※Life time : Min 산출 : MTTF

## 6. Ranks

### (1) Luminous Intensity

Code	Condition	Min.	Max.	Unit
H0	IF=93mA	17.0	18.0	cd
J0		18.0	19.0	
K0		19.0	20.0	
L0		20.0	21.0	
M0		21.0	22.0	
N0		22.0	23.0	

### (2) Forward Voltage

Code	Condition	Min.	Max.	Unit
0	IF = 93mA	6.0	6.1	V
1		6.1	6.2	
2		6.2	6.3	
3		6.3	6.4	
4		6.4	6.5	
5		6.5	6.6	
6		6.6	6.7	
7		6.7	6.8	

**(3) Peak Wavelength**

Code	Condition	Min.	Max.	Unit
A	IF = 93mA	435.5	440.5	nm
B		440.5	446.5	
C		446.5	451.5	

**(4) Chromaticity Coordinates Diagram**

IF=93mA (Ta = 25°C)

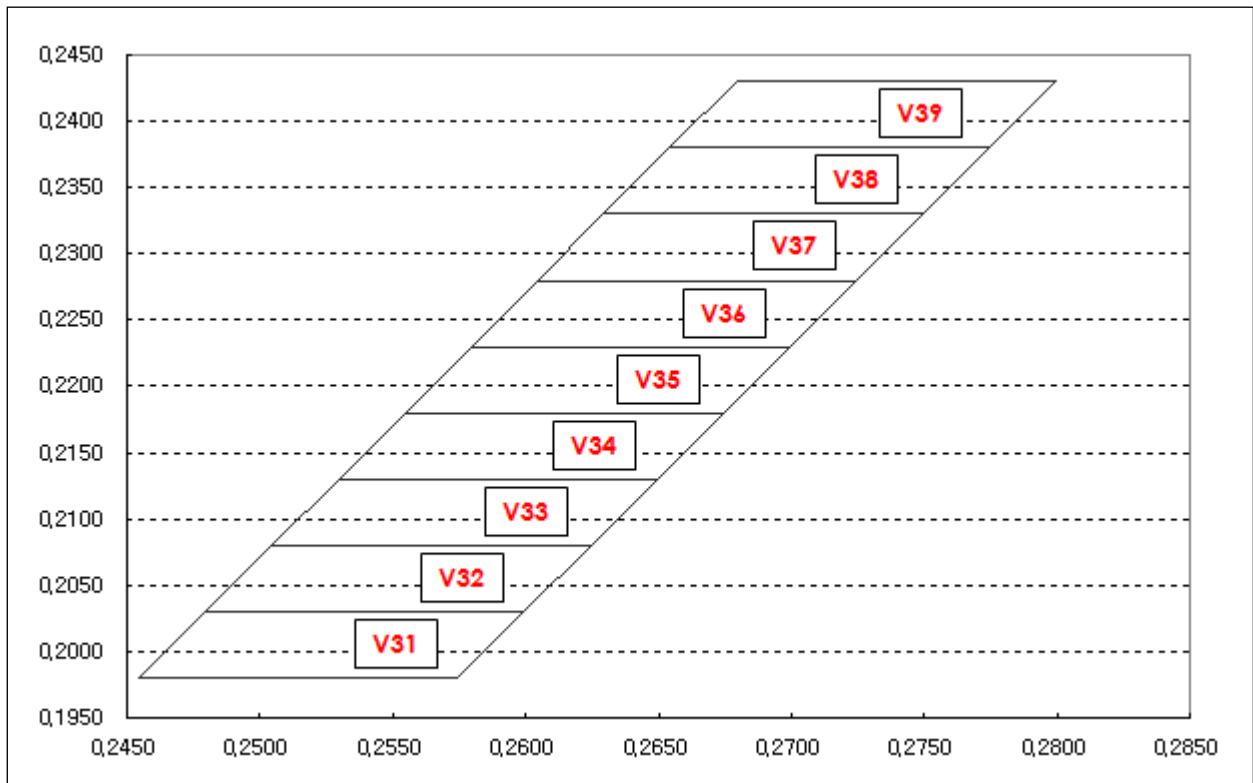

(5) Color spectrum

IF=93mA (Ta = 25°C)

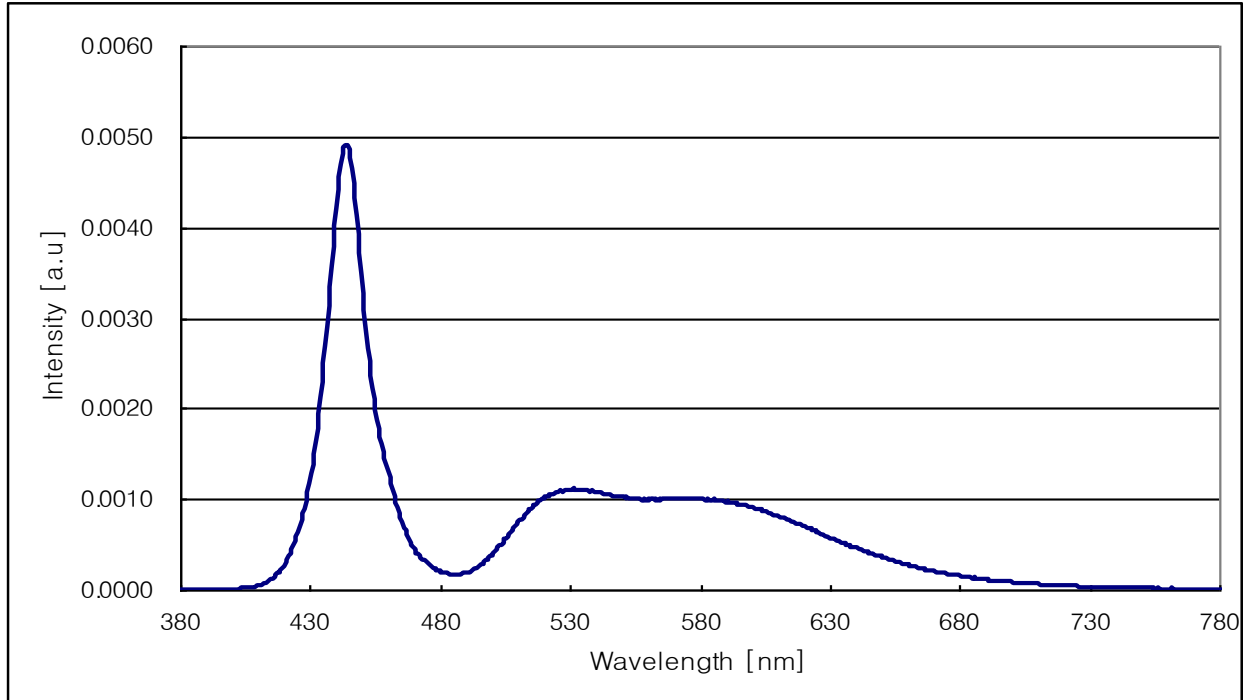



# 7. Characteristic Diagrams

(1) Forward Voltage vs Forward Current

(Ta = 25°C)

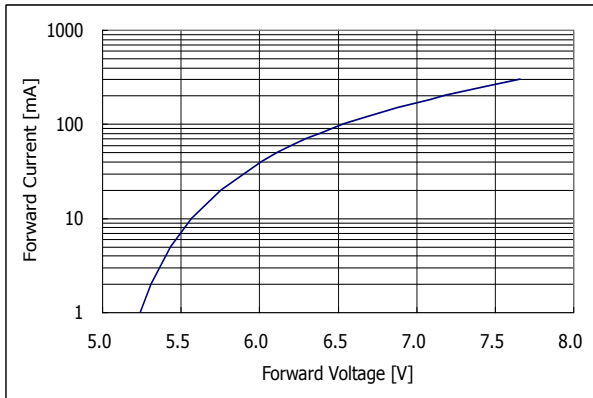

(2) Forward Current vs L-Flux

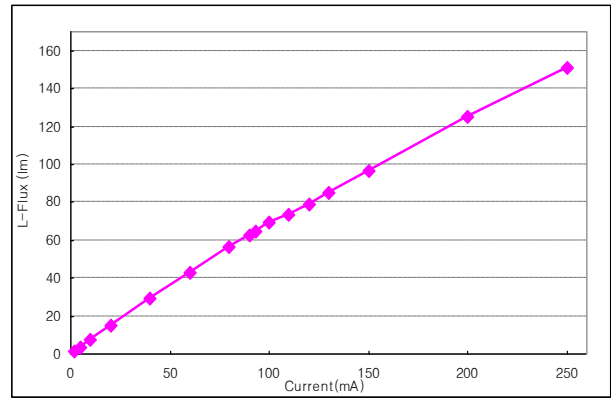

(3) CIE<sub>x</sub>, Δ CIE<sub>y</sub> vs. Forward Current

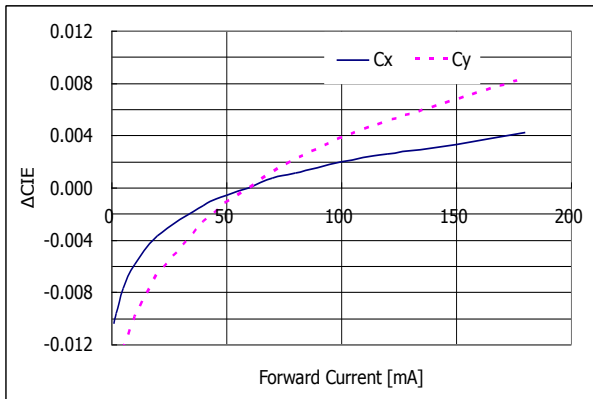

(4) CIE<sub>x</sub>, Δ CIE<sub>y</sub> vs. Temperature

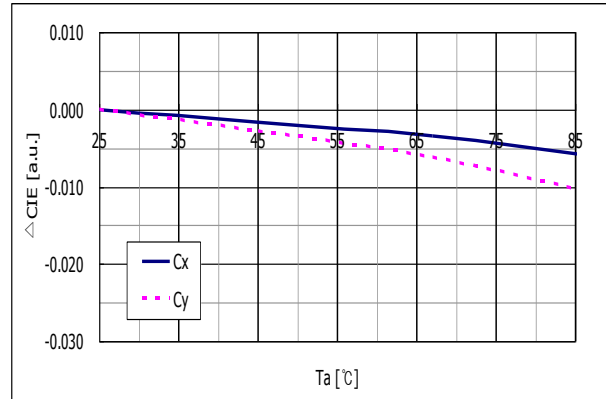

(5) View angle profile

IF= 93mA

(Temp: 25°C)

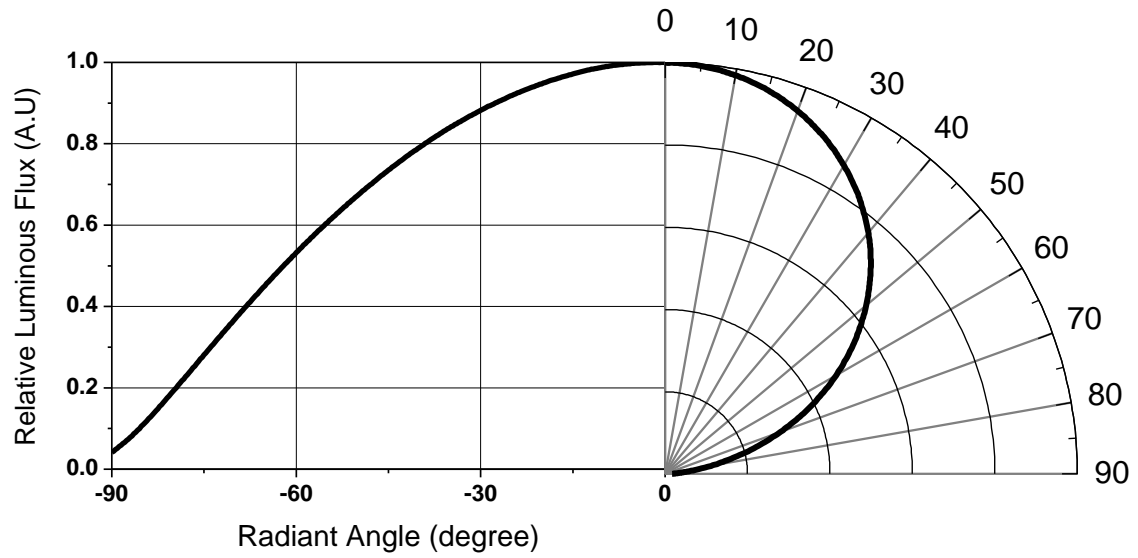

## 8. Reliability

### (1) Test items and results

NO	Test Item	Standard Test Method	Test Conditions	Note	Number of Damaged
1	Resistance to Soldering Heat (Reflow Soldering)	JEITA ED-4701 300 301	Tsld=260°C, 10sec.  (Pre treatment 30°C,70%,168hrs)	2 times	0/20
2	Solderability (Reflow Soldering)	JEITA ED-4701 300 303	Tsld=245±5°C, 3sec  (Lead Solder)	1 time  over 95%	0/20
3	Temperature Cycle	JEITA ED-4701 100 105	-45°C - 125°C  30min - 30min	100 cycles	0/20
4	Temperature Cycle	JEITA ED-4701 100 105	-40°C - 100°C  30min - 30min	100 cycles	0/20
5	High Temperature Storage	JEITA ED-4701 200 201	Ta=100°C	1000 hrs	0/20
6	Temperature Humidity Storage	JEITA ED-4701 100 103	Ta=85°C, RH=85%	1000 hrs	0/20
7	Low Temperature Storage	JEITA ED-4701 200 202	Ta=-40°C	1000 hrs	0/20
8	Steady State Operating Life	-	Ta=25°C, IF=150mA	1000 hrs	0/20

9	Steady State Operating Life of High Temperature	-	Ta=65°C, IF=150mA	1000 hrs	0/20
10	Steady State Operating Life of High Temperature	-	Ta=85°C, IF=150mA	1000 hrs	0/20
11	Steady State Operating Life of High Humidity Heat	-	Ta=85°C, RH=85%, IF=150mA	500 hrs	0/20
12	Steady State Operating Life of Low Temperature	-	Ta=-40°C, IF=150mA	1000 hrs	0/20
13	Electro-Static Discharge Threshold	ESD (HBM)	1500Ω, 100pF (Forward/Reverse)	6000V	0/20

(2) Criteria for judging the damage

ITEM	Symbol	Test Condition	Criteria for Judgement	
			Min.	Max.
Forward Voltage	VF	IF = 93mA	-	U.S.L. *1) × 1.1
Luminous Flux	Φv	IF = 93mA	L.S.L.*2) × 0.7	-

\*1) U.S.L. : Upper Standard Level

\*2) L.S.L : Lower Standard Level

(3) Silicone Depth Judgement

Silicone Depth Spec

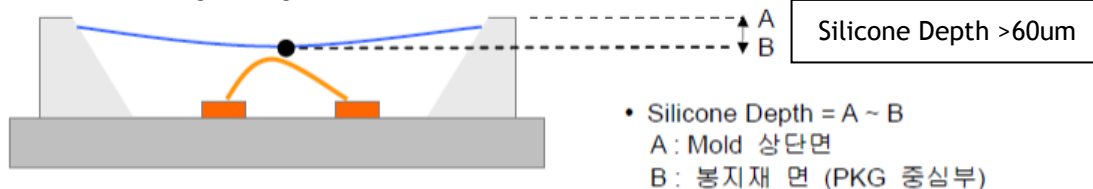

Silicone Depth Spec 불량

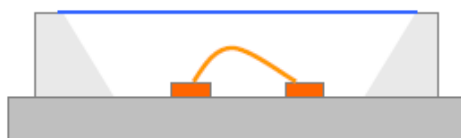

• LED PKG Silicone Depth = 0 um (Flat) 으로 불량 임.

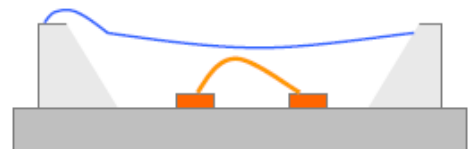

• 봉지재가 Mold 상단면을 넘침으로 불량 임.

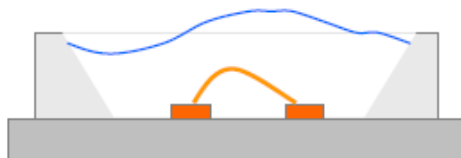

• 봉지재의 중심 또는 일부가 Mold 상단면 보다 높출 되므로 불량 임.

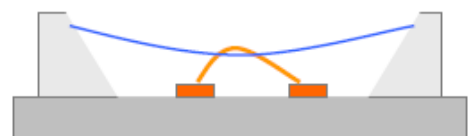

• Wire가 봉지재 위로 노출되어 불량 임.

## 9 . Precautions to taken

### (1) Recommend soldering conditions

Reflow Soldering			Hand Soldering(Lead Part)	
	Lead Solder	Lead Free Solder		
Pre-heat	120~150°C	180~200°C	Temperature	Max. 340°C
Pre-heat time	120sec	120sec. Max.	Soldering	Max. 3sec
Peak temperature	Max. 240°C	Max. 260°C	Time	(only one time)
Soldering Time	Max. 10sec	Max. 10sec		
Condition				

### Temperature-profile

#### <Lead Solder>

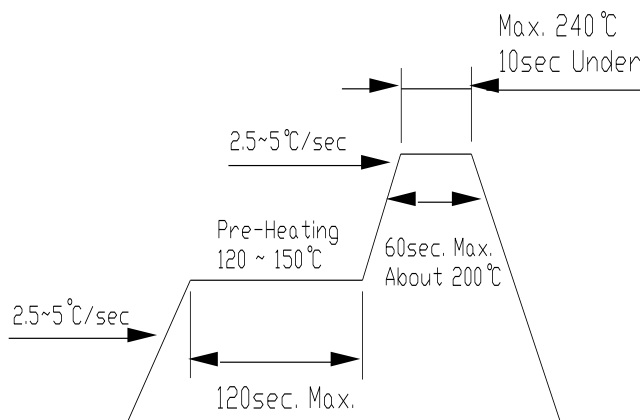

#### <Lead-free Solder>

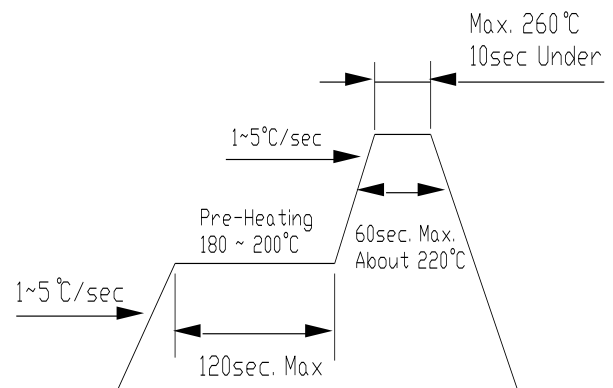

### <Recommended soldering pad design>

Unit: mm

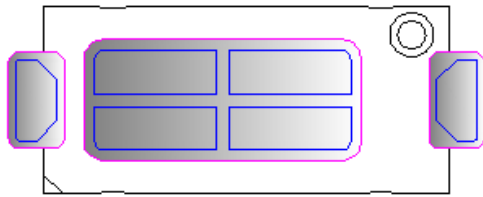

Solder Land

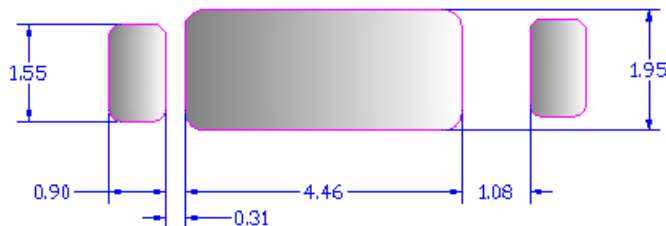

Soldering Pad Tolerance :  $\pm 0.1$ mm

### (2)Moisture Proof Package

When moisture is absorbed into the SMT package it may vaporize and expand during soldering. There is a possibility that this can cause exfoliation of the contacts and damage to the optical characteristics of the LEDs. For this reason, the moisture proof package is used to keep moisture to a minimum in the package. The moisture proof package is made of an aluminum moisture proof bag. A package

of a moisture absorbent material(silica gel) is inserted into the aluminum moisture proof bag. The silica gel changes its color from blue to pink as it absorbs moisture.

### (3)Storage

[Storage conditions]

Before opening the package

The LEDs should be kept at 30°C or less and 90% RH or less. The LEDs should be used within a year. When storing the LEDs, moisture proof packaging with absorbent material(silica gel) is recommended.

After opening the package

The LEDs should be kept at 30°C or less and 70% RH or less. The LEDs should be soldered within 168 hours(7days) after opening the package. If unused LEDs remain, they should be stored in moisture proof packages, such as sealed containers with package of moisture absorbent material(silica gel). It is also recommended to return the LEDs to the original moisture proof bag and to reseal the moisture proof bag again.

If the moisture absorbent material(silica gel) has faded away or the LEDs have exceeded the storage time, baking treatment should be performed using the following conditions.

Baking treatment : more than 24hours at 65±5°C

WOOREE LED part's electrodes and leadframes are silver plated copper alloy.

The silver surface may be affected by environments which contain corrosive substances.

Please avoid conditions which may cause the LED to corrode, tarnish or discolor.

The corrosion or discoloration might lower solderability or might affect on optical Characteristics.

Please avoid rapid transitions in ambient temperature, especially in high humidity environments where condensation can occur.

#### **(4)Heat Generation**

Thermal design of the end product is of paramount importance. Please consider the heat generation of the LED when making the system design. The coefficient of temperature increase per input electric power is affected by the thermal resistance of the circuit board and density of LED placement on the board, as well as other components. It is necessary to avoid intense heat generation and operate within the maximum ratings given in the specification.

The operating current should be decided after considering the ambient maximum temperature of LEDs.



#### **(5) Handling Precautions**

When handling the product, touching encapsulant with bare hands will contaminate its surface that could affect optical characteristics. In the worst cases, excessive force to the encapsulant by hand might result in catastrophic failure of the LEDs due to wire deformation and/or breakage.

# 10. Packaging & Label

## (1) Taping part

unit : mm  
tolerance : ± 0.1

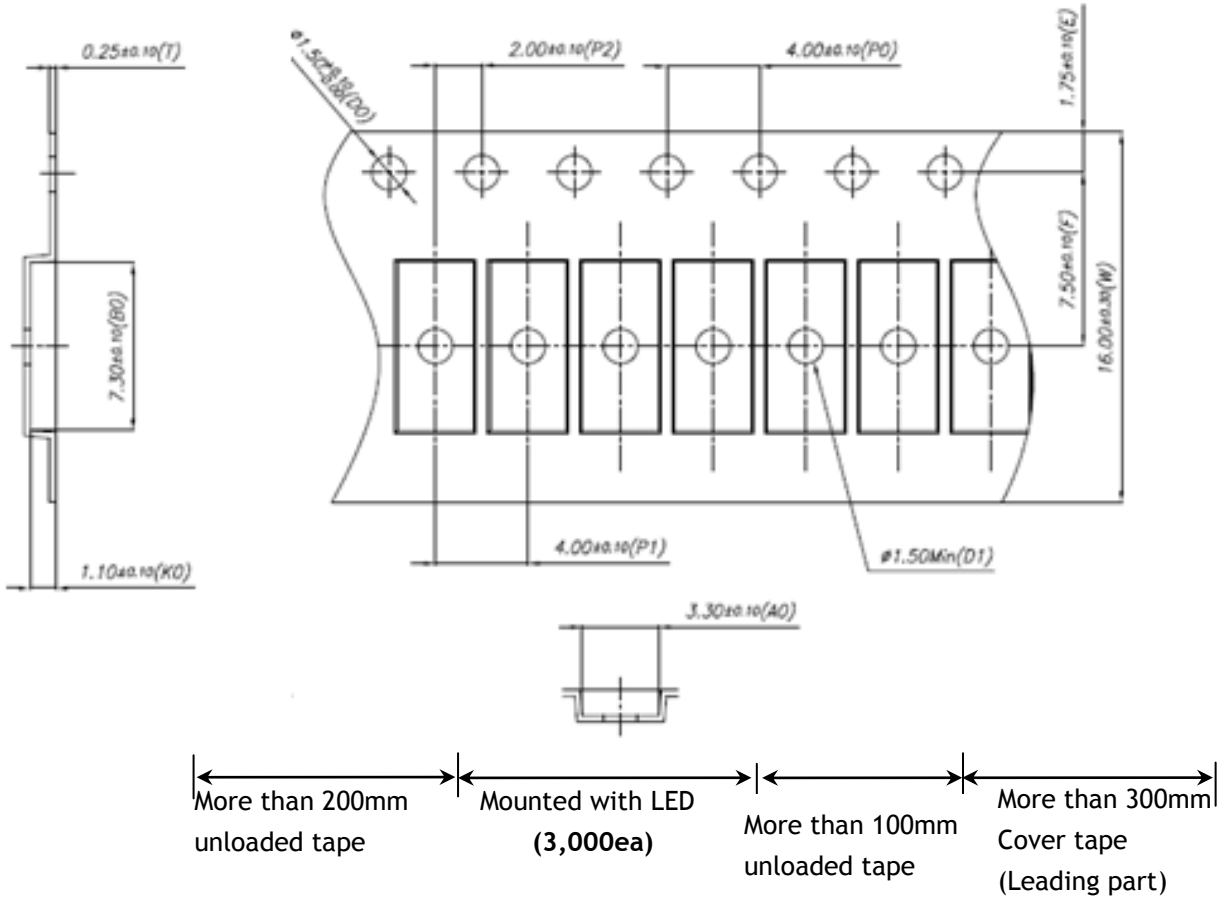

## (2) Reel part (Q'ty : 3,000ea/Reel)

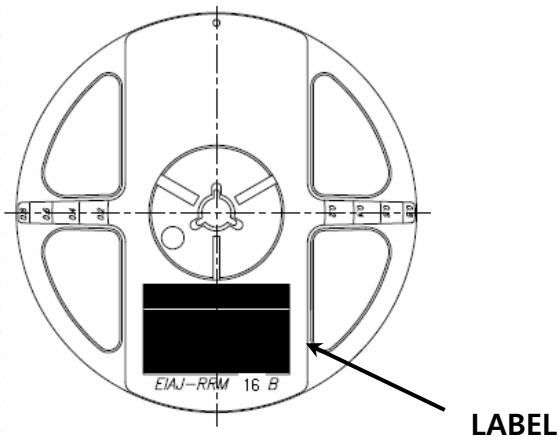

**(3) Boxing**

**Shield Bag (with Silica gel)**

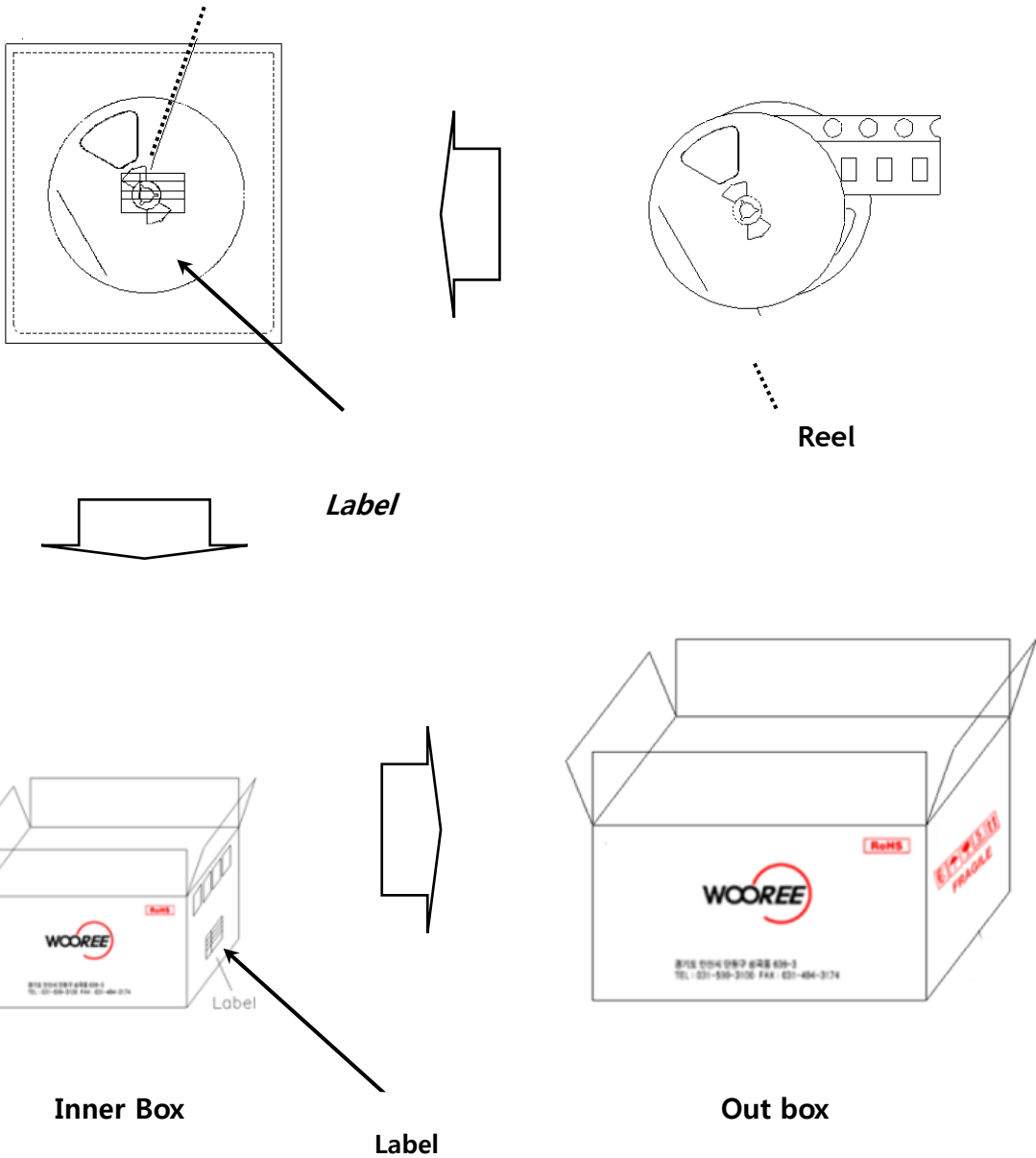

Box	Dimension (mm)	Reel/Box	Quantity/Box
Inner box	500*260*250	30 Reel max.	90,000 ea
Out box	555*515*540	120 Reel max.	360,000 ea

#### (4) Label Information

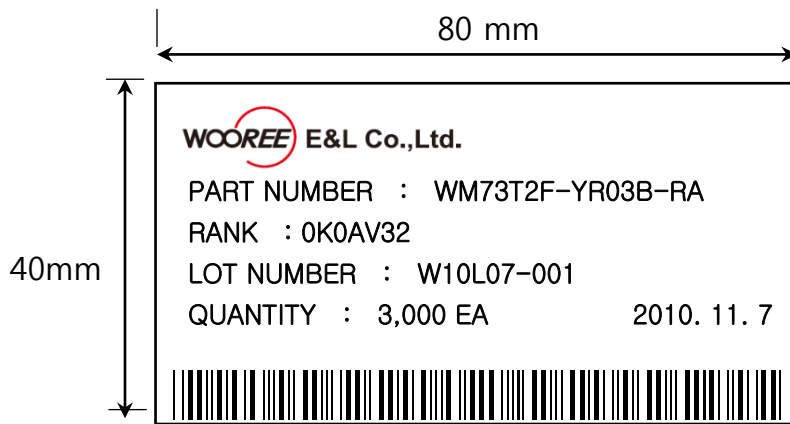

#### (5) Lot Number



①      ②      ③      ④                      ⑤

- ① WOOREE LED Initial
- ② Year (10 for 2010, 11 for 2011)
- ③ Month (A for Jan., B for Feb., ... , N for Dec.)
- ④ Day (01 for 1,....31 for 31)
- ⑤ WOOREE LED Product Running Number

**(6) Rank Code description**

