

Customer :

# Specification for Approval

---

---

Part Name : WH53N2F-xx80B

**(Preliminary)**

Customer : \_\_\_\_\_ 2015. \_\_\_\_ . \_\_\_\_ .

Checked	Checked	Approved	Remark
/	/	/	

WOOREE E&L Co., Ltd. 2015. 01. 28.

Designed	Checked	Approved
/	/	/

---

**WOOREE E&L CO., LTD** 636-3, Sunggok-dong, Danwon-gu, Ansan-si, Kyunggy-do, Korea.

Tel (031)599-3013 Fax (031)494-3174

 **WOOREE** E&L Co.,Ltd.

# CONTENTS

1. Features
2. Outline Dimension
3. Absolute Maximum Ratings
4. Electrical / Optical Characteristics
5. Ranks
6. Color Spectrum
7. Characteristic Diagrams
8. Reliability
9. Recommend soldering conditions
10. Packing
11. Revision History

## 1. Features

- SMD Top View Type
- Long Time Reliability (with ESD Protection)
- Package size is 5.6 \* 3.0\* 0.8t (mm)
- Application : General Lighting

## 2. Outline Dimension

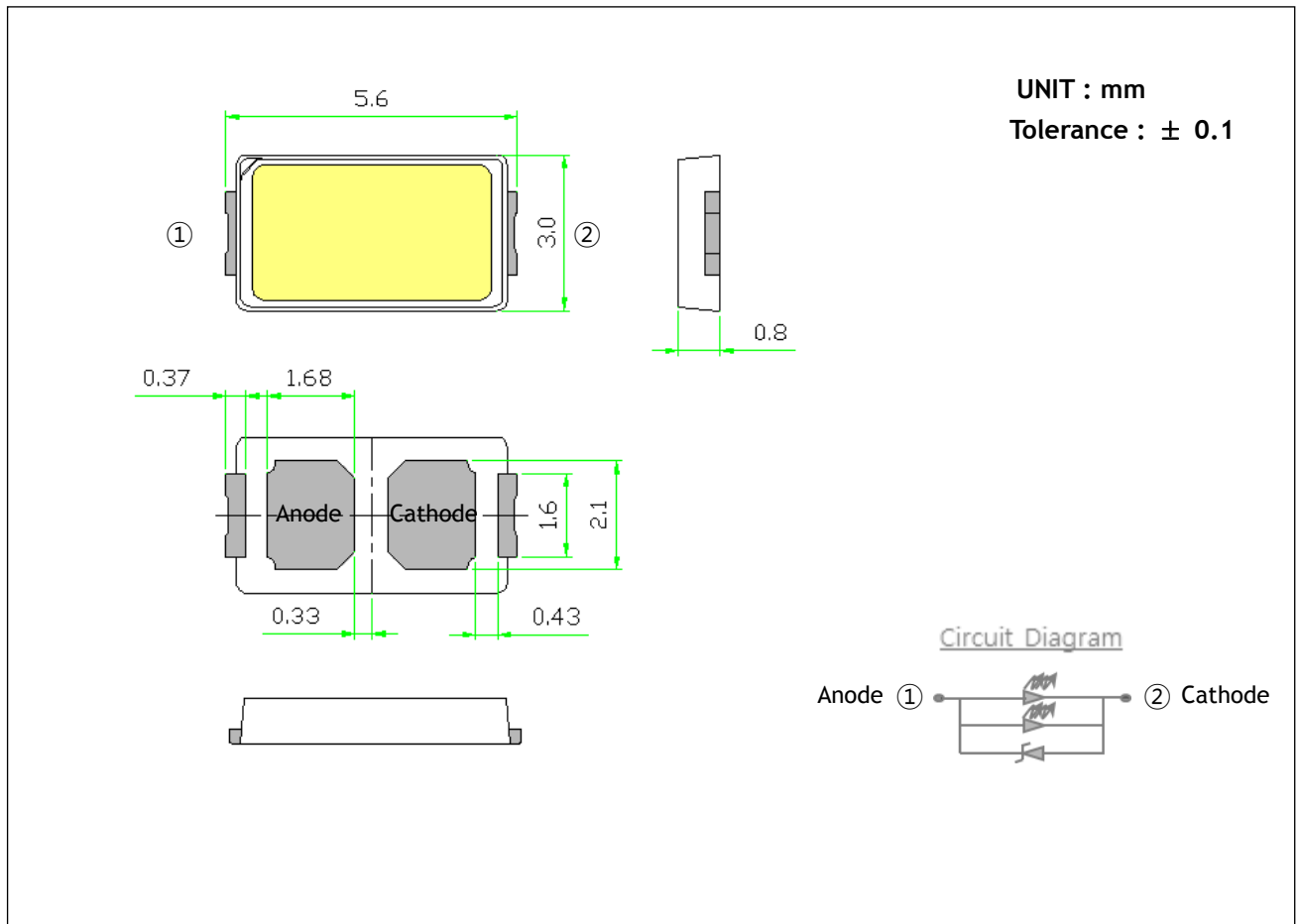

### Part list

Parts No.	Name	Description
1	Chip source	Blue LED
2	Body	Thermo Plastic
3	Lead frame base	Metal
4	Phosphor	Red, Green color Emitting
5	Resin	Encapsulant

### 3. Absolute maximum ratings

Item	Symbol	Absolute Maximum Ratings	Unit
Forward Current	$I_F$	200	mA
Pulse Forward Current*1	$I_{FP}$	300	mA
Power Dissipation	$P_D$	0.5	W
Operating Temperature	$T_{OPR}$	-40 ~ +85	°C
Storage Temperature	$T_S$	-40 ~ +100	°C
Solder Temperature	$T_{SLD}$	Reflow 260 °C, 10sec under Hand 340 °C 3sec under	°C
Junction Temperature	$T_J$	100	°C

\*1. Pulse Width ≤ 10msec, Duty ≤ 10%

### 4. Electrical/Optical characteristics

(Ta=25°C)

Item	Symbol	Condition	Value			Unit
			Min	Typ.	Max	
Forward Voltage *1	$V_F$	$I_F=65mA$	2.75	2.85	2.95	V
Luminous Flux*2	$\Phi_V$	$I_F=65mA$	30.0	-	38.0	lm
Color Temperature *3 [CIE 1931 Coordinates]	CCT	$I_F=65mA$	2580	-	7040	K
Viewing Angle	$2\theta_{1/2}$	$I_F=65mA$	-	120	-	Deg.
Color Rendering Index	Ra	$I_F=65mA$	80	-	-	-
Thermal Resistance	$R_{th}$	$I_F=65mA$	-	14	-	°C/W

\*1. Forward voltage measurement allowance is ±0.05V

\*2. Luminous Flux measurement allowance is ±5%

\*3. Color Temperature measurement allowance is ±100K

## 5. Ranks

(1) Forward Voltage

(Ta=25℃)

Rank	Condition	Min.	Max.	Unit
7	I <sub>F</sub> = 65mA	2.75	2.85	V
8		2.85	2.95	

(2) Luminous Intensity

(I<sub>F</sub> = 65mA, Ta=25℃)

Rank	2700K	3000K	4000K	5000K	5700K	6500K	Unit
W30	30.0-32.0	30.0-32.0	-	-	-	-	lm
W32	32.0-34.0	32.0-34.0	32.0-34.0	32.0-34.0	32.0-34.0	32.0-34.0	
W34	-	34.0-36.0	34.0-36.0	34.0-36.0	34.0-36.0	34.0-36.0	
W36	-	-	-	36.0-38.0	-	-	

(3) Chromaticity coordinates - Warm White

( $I_F = 65\text{mA}$ ,  $T_a = 25^\circ\text{C}$ )

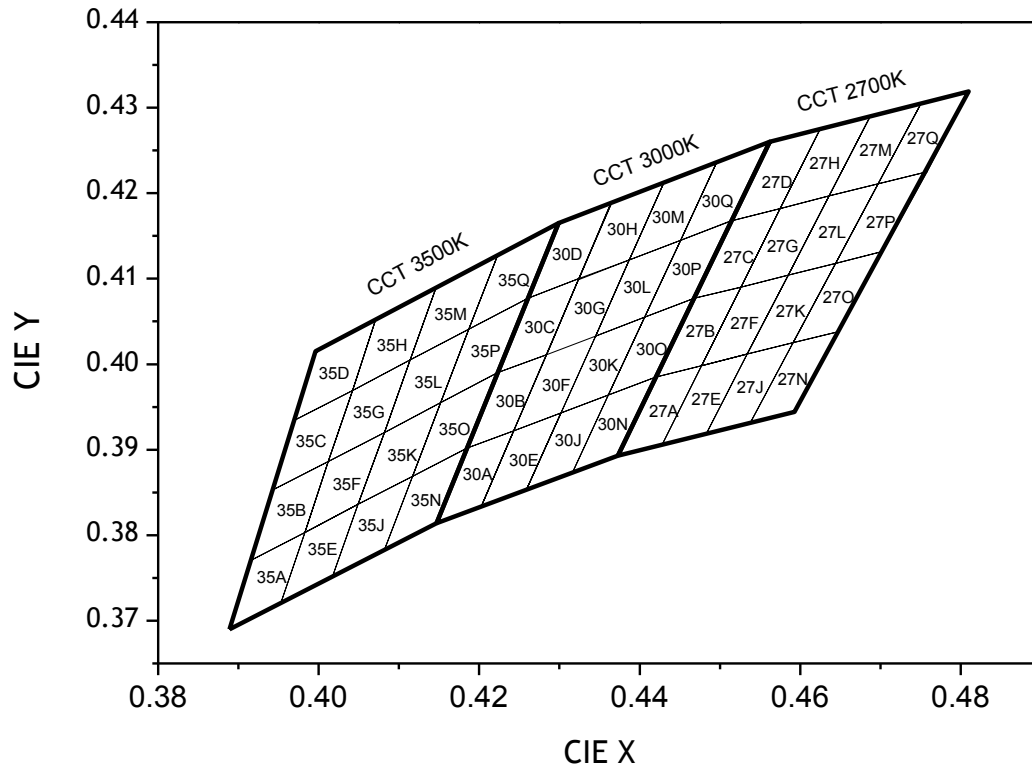

2700K ( CCT 2793 - 2870K )

27A		27B		27C		27D	
x	y	x	y	x	y	x	y
0.4373	0.3893	0.4420	0.3985	0.4468	0.4077	0.4515	0.4168
0.4420	0.3985	0.4468	0.4077	0.4515	0.4168	0.4562	0.4260
0.4477	0.3998	0.4526	0.4090	0.4575	0.4182	0.4625	0.4275
0.4428	0.3906	0.4477	0.3998	0.4526	0.4090	0.4575	0.4182

2700K ( CCT 2719 - 2793K )

27E		27F		27G		27H	
x	y	x	y	x	y	x	y
0.4428	0.3906	0.4477	0.3998	0.4526	0.4090	0.4575	0.4182
0.4477	0.3998	0.4526	0.4090	0.4575	0.4182	0.4625	0.4275
0.4534	0.4012	0.4585	0.4104	0.4636	0.4197	0.4687	0.4289
0.4483	0.3919	0.4534	0.4012	0.4585	0.4104	0.4636	0.4197

2700K ( CCT 2648 - 2719K )

27J		27K		27L		27M	
x	y	x	y	x	y	x	y
0.4483	0.3919	0.4534	0.4012	0.4585	0.4104	0.4636	0.4197
0.4534	0.4012	0.4585	0.4104	0.4636	0.4197	0.4687	0.4289
0.4591	0.4025	0.4644	0.4118	0.4697	0.4211	0.4750	0.4304
0.4538	0.3932	0.4591	0.4025	0.4644	0.4118	0.4697	0.4211

2700K ( CCT 2580 - 2648K )

27N		27O		27P		27Q	
x	y	x	y	x	y	x	y
0.4538	0.3932	0.4591	0.4025	0.4644	0.4118	0.4697	0.4211
0.4591	0.4025	0.4644	0.4118	0.4697	0.4211	0.4750	0.4304
0.4648	0.4038	0.4703	0.4132	0.4758	0.4225	0.4810	0.4319
0.4593	0.3944	0.4648	0.4038	0.4703	0.4132	0.4758	0.4225

3000K ( CCT 3125 - 3220K )

30A		30B		30C		30D	
x	y	x	y	x	y	x	y
0.4147	0.3814	0.4185	0.3902	0.4223	0.3990	0.4261	0.4077
0.4185	0.3902	0.4223	0.3990	0.4261	0.4077	0.4299	0.4165
0.4243	0.3922	0.4284	0.4011	0.4324	0.4100	0.4365	0.4189
0.4203	0.3834	0.4243	0.3922	0.4284	0.4011	0.4324	0.4100

3000K ( CCT 3035 - 3125K )

30E		30F		30G		30H	
x	y	x	y	x	y	x	y
0.4259	0.3853	0.4243	0.3922	0.4284	0.4011	0.4324	0.4099
0.4302	0.3943	0.4284	0.4011	0.4324	0.4100	0.4364	0.4188
0.4243	0.3922	0.4345	0.4033	0.4387	0.4122	0.4430	0.4212
0.4203	0.3834	0.4302	0.3943	0.4345	0.4033	0.4387	0.4122

3000K ( CCT 2952 - 3035K )

30J		30K		30L		30M	
x	y	x	y	x	y	x	y
0.4259	0.3853	0.4302	0.3943	0.4345	0.4033	0.4387	0.4122
0.4302	0.3943	0.4345	0.4033	0.4387	0.4122	0.4430	0.4212
0.4361	0.3964	0.4406	0.4055	0.4451	0.4145	0.4496	0.4236
0.4316	0.3873	0.4361	0.3964	0.4406	0.4055	0.4451	0.4145

3000K ( CCT 2870 - 2952K )

30N		30O		30P		30Q	
x	y	x	y	x	y	x	y
0.4316	0.3873	0.4361	0.3964	0.4406	0.4055	0.4451	0.4145
0.4361	0.3964	0.4406	0.4055	0.4451	0.4145	0.4496	0.4236
0.4420	0.3985	0.4468	0.4077	0.4515	0.4168	0.4562	0.4260
0.4373	0.3893	0.4420	0.3985	0.4468	0.4077	0.4514	0.4168



3500K ( CCT 3574 - 3710K )

35A		35B		35C		35D	
x	y	x	y	x	y	x	y
0.3889	0.3690	0.3916	0.3771	0.3943	0.3853	0.3969	0.3934
0.3916	0.3771	0.3943	0.3853	0.3969	0.3934	0.3996	0.4015
0.3983	0.3803	0.4012	0.3886	0.4042	0.3969	0.4071	0.4052
0.3953	0.3721	0.3983	0.3803	0.4012	0.3886	0.4042	0.3969

3500K ( CCT 3447 - 35747K )

35E		35F		35G		35H	
x	y	x	y	x	y	x	y
0.3953	0.3721	0.3983	0.3803	0.4012	0.3886	0.4042	0.3969
0.3983	0.3803	0.4012	0.3886	0.4042	0.3969	0.4071	0.4052
0.4049	0.3836	0.4082	0.3920	0.4114	0.4005	0.4146	0.4089
0.4017	0.3751	0.4049	0.3836	0.4082	0.3920	0.4114	0.4005

3500K ( CCT 3329 - 3447K )

35J		35K		35L		35M	
x	y	x	y	x	y	x	y
0.4017	0.3751	0.4049	0.3836	0.4082	0.3920	0.4114	0.4005
0.4049	0.3836	0.4082	0.3920	0.4114	0.4005	0.4146	0.4089
0.4117	0.3869	0.4152	0.3955	0.4187	0.4041	0.4223	0.4127
0.4082	0.3783	0.4117	0.3869	0.4152	0.3955	0.4187	0.4041

3500K ( CCT 3220 - 3329K )

35N		35O		35P		35Q	
x	y	x	y	x	y	x	y
0.4082	0.3783	0.4117	0.3869	0.4152	0.3955	0.4187	0.4041
0.4117	0.3869	0.4152	0.3955	0.4187	0.4041	0.4223	0.4127
0.4185	0.3902	0.4223	0.3990	0.4261	0.4077	0.4299	0.4165
0.4147	0.3814	0.4185	0.3902	0.4223	0.3990	0.4261	0.4077

(4) Chromaticity coordinates - Neutral White

( $I_F = 65\text{mA}$ ,  $T_a = 25^\circ\text{C}$ )

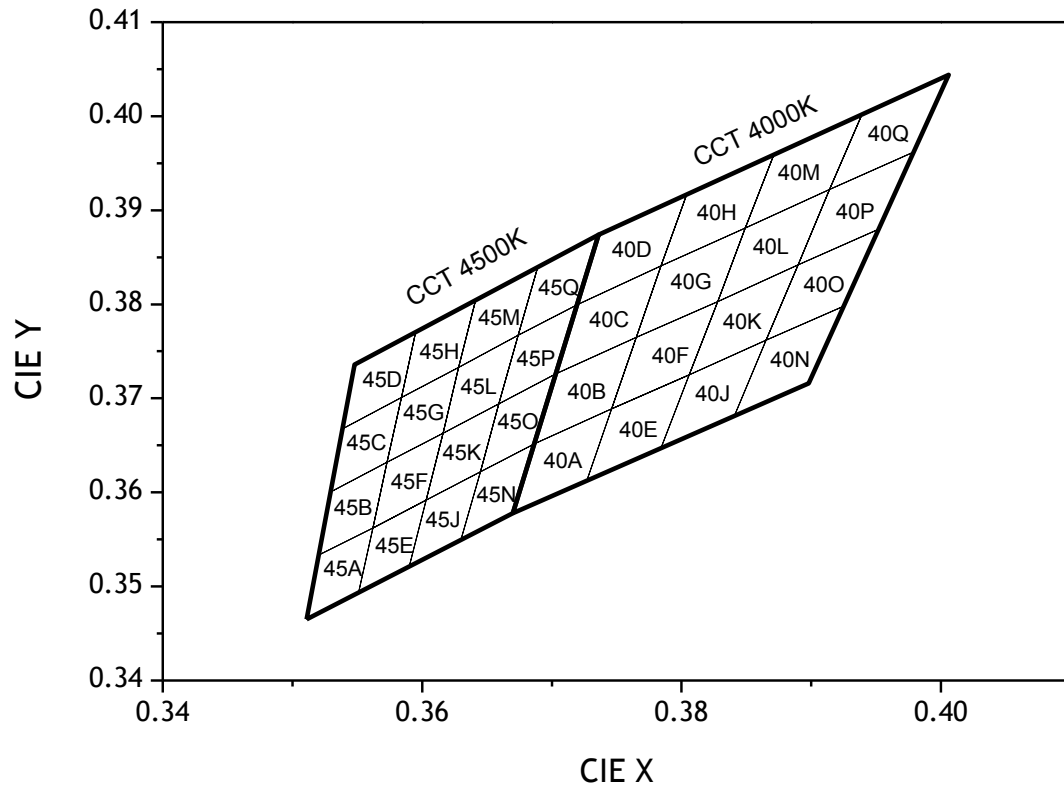

4000K ( CCT 4107 - 4260K )

40A		40B		40C		40D	
x	y	x	y	x	y	x	y
0.3670	0.3578	0.3687	0.3652	0.3703	0.3726	0.3720	0.3800
0.3687	0.3652	0.3703	0.3726	0.3720	0.3800	0.3736	0.3874
0.3746	0.3689	0.3765	0.3765	0.3784	0.3841	0.3804	0.3917
0.3727	0.3613	0.3746	0.3689	0.3765	0.3765	0.3784	0.3841

4000K ( CCT 3964 - 4107K )

40E		40F		40G		40H	
x	y	x	y	x	y	x	y
0.3727	0.3613	0.3746	0.3689	0.3765	0.3765	0.3784	0.3841
0.3746	0.3689	0.3765	0.3765	0.3784	0.3841	0.3804	0.3917
0.3806	0.3725	0.3828	0.3803	0.3849	0.3881	0.3871	0.3959
0.3784	0.3647	0.3806	0.3725	0.3828	0.3803	0.3849	0.3881

4000K ( CCT 3832 - 3964K )

40J		40K		40L		40M	
x	y	x	y	x	y	x	y
0.3784	0.3647	0.3806	0.3725	0.3828	0.3803	0.3849	0.3881
0.3806	0.3725	0.3828	0.3803	0.3849	0.3881	0.3871	0.3959
0.3865	0.3762	0.3890	0.3842	0.3914	0.3922	0.3939	0.4002
0.3841	0.3682	0.3865	0.3762	0.3890	0.3842	0.3914	0.3922

4000K ( CCT 3710 - 3832K )

40N		40O		40P		40Q	
x	y	x	y	x	y	x	y
0.3841	0.3682	0.3865	0.3762	0.3890	0.3842	0.3914	0.3922
0.3865	0.3762	0.3890	0.3842	0.3914	0.3922	0.3939	0.4002
0.3925	0.3798	0.3952	0.3880	0.3979	0.3962	0.4006	0.4044
0.3898	0.3716	0.3925	0.3798	0.3952	0.3880	0.3979	0.3962

4500K ( CCT 4613 - 4745K )

45A		45B		45C		45D	
x	y	x	y	x	y	x	y
0.3511	0.3465	0.3520	0.3533	0.3530	0.3601	0.3539	0.3668
0.3520	0.3533	0.3530	0.3601	0.3539	0.3668	0.3548	0.3736
0.3562	0.3562	0.3573	0.3632	0.3584	0.3701	0.3595	0.3770
0.3551	0.3493	0.3562	0.3562	0.3573	0.3632	0.3584	0.3701

4500K ( CCT 4488 - 4613K )

45E		45F		45G		45H	
x	y	x	y	x	y	x	y
0.3551	0.3493	0.3562	0.3562	0.3573	0.3632	0.3584	0.3701
0.3562	0.3562	0.3573	0.3632	0.3584	0.3701	0.3595	0.3770
0.3603	0.3592	0.3616	0.3663	0.3628	0.3733	0.3641	0.3804
0.3590	0.3521	0.3603	0.3592	0.3616	0.3663	0.3628	0.3733

4500K ( CCT 4371 - 4488K )

45J		45K		45L		45M	
x	y	x	y	x	y	x	y
0.3590	0.3521	0.3603	0.3592	0.3616	0.3663	0.3628	0.3733
0.3603	0.3592	0.3616	0.3663	0.3628	0.3733	0.3641	0.3804
0.3645	0.3622	0.3659	0.3694	0.3674	0.3767	0.3689	0.3839
0.3630	0.3550	0.3645	0.3622	0.3659	0.3694	0.3674	0.3767

4500K ( CCT 4260 - 4371K )

45N		45O		45P		45Q	
x	y	x	y	x	y	x	y
0.3630	0.3550	0.3645	0.3622	0.3659	0.3694	0.3674	0.3767
0.3645	0.3622	0.3659	0.3694	0.3674	0.3767	0.3689	0.3839
0.3687	0.3652	0.3703	0.3726	0.3720	0.3800	0.3736	0.3874
0.3670	0.3578	0.3687	0.3652	0.3703	0.3726	0.3720	0.3800

(5) Chromaticity coordinates - Cool White

( $I_F = 65\text{mA}$ ,  $T_a = 25^\circ\text{C}$ )

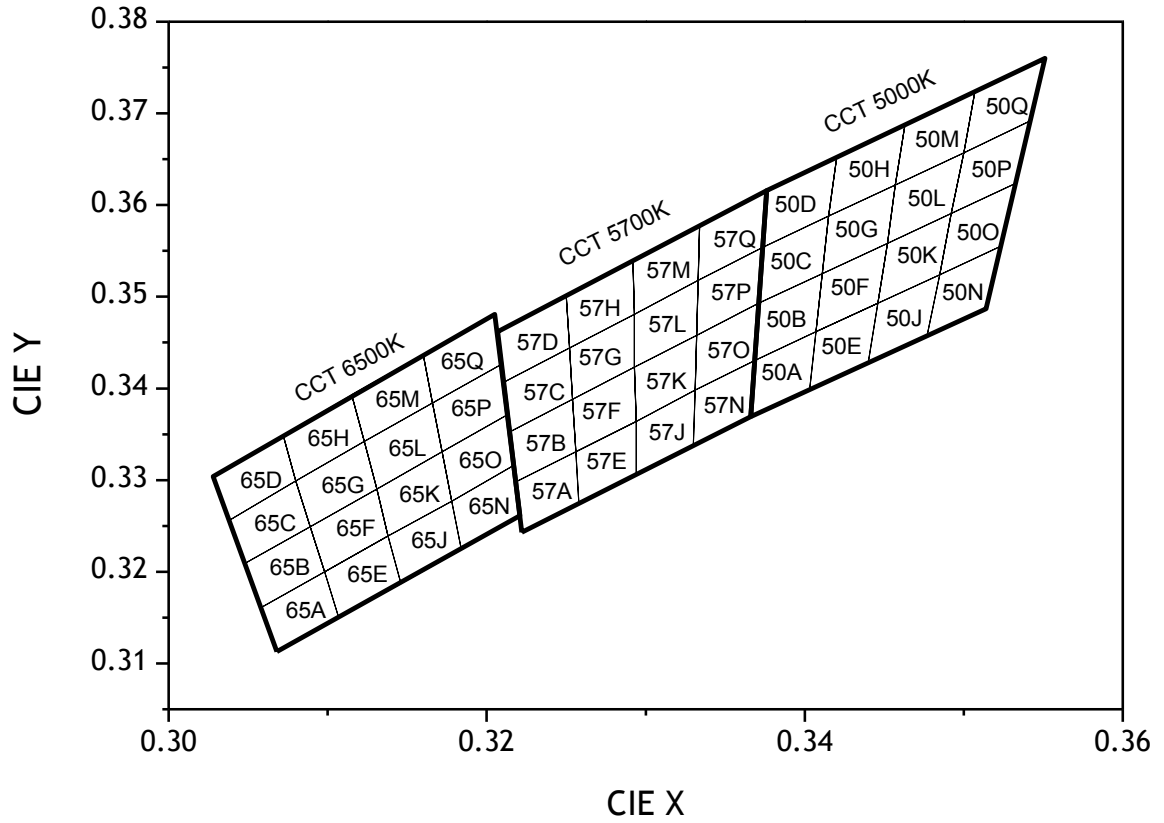

5000K ( CCT 5155 - 5311K )

50A		50B		50C		50D	
x	y	x	y	x	y	x	y
0.3366	0.3369	0.3369	0.3431	0.3371	0.3493	0.3374	0.3554
0.3369	0.3431	0.3371	0.3493	0.3374	0.3554	0.3376	0.3616
0.3407	0.3462	0.3411	0.3525	0.3415	0.3588	0.3420	0.3652
0.3403	0.3399	0.3407	0.3462	0.3411	0.3525	0.3415	0.3588

5000K ( CCT 5010 - 5155K )

50E		50F		50G		50H	
x	y	x	y	x	y	x	y
0.3403	0.3399	0.3407	0.3462	0.3411	0.3525	0.3415	0.3588
0.3407	0.3462	0.3411	0.3525	0.3415	0.3588	0.3420	0.3652
0.3446	0.3493	0.3452	0.3558	0.3457	0.3622	0.3463	0.3687
0.3440	0.3428	0.3446	0.3493	0.3452	0.3558	0.3457	0.3622

5000K ( CCT 4874 - 5010K )

50J		50K		50L		50M	
x	y	x	y	x	y	x	y
0.3440	0.3428	0.3446	0.3493	0.3452	0.3558	0.3457	0.3622
0.3446	0.3493	0.3452	0.3558	0.3457	0.3622	0.3463	0.3687
0.3485	0.3524	0.3492	0.3591	0.3500	0.3657	0.3507	0.3724
0.3477	0.3458	0.3485	0.3524	0.3492	0.3591	0.3500	0.3657

5000K ( CCT 4745 - 4874K )

50N		50O		50P		50Q	
x	y	x	y	x	y	x	y
0.3477	0.3458	0.3485	0.3524	0.3492	0.3591	0.3500	0.3657
0.3485	0.3524	0.3492	0.3591	0.3500	0.3657	0.3507	0.3724
0.3523	0.3555	0.3533	0.3624	0.3542	0.3692	0.3551	0.3760
0.3514	0.3487	0.3523	0.3555	0.3533	0.3624	0.3542	0.3692

5700K ( CCT 5823 - 6020K )

57A		57B		57C		57D	
x	y	x	y	x	y	x	y
0.3222	0.3243	0.3218	0.3298	0.3215	0.3353	0.3211	0.3407
0.3218	0.3298	0.3215	0.3353	0.3211	0.3407	0.3207	0.3462
0.3256	0.3331	0.3254	0.3388	0.3252	0.3444	0.3250	0.3501
0.3258	0.3275	0.3256	0.3331	0.3254	0.3388	0.3252	0.3444

5700K ( CCT 5641 - 5823K )

57E		57F		57G		57H	
x	y	x	y	x	y	x	y
0.3258	0.3275	0.3256	0.3331	0.3254	0.3388	0.3252	0.3444
0.3256	0.3331	0.3254	0.3388	0.3252	0.3444	0.3250	0.3501
0.3294	0.3364	0.3293	0.3423	0.3293	0.3481	0.3292	0.3539
0.3294	0.3306	0.3294	0.3364	0.3293	0.3423	0.3293	0.3481

5700K ( CCT 5468 - 5641K )

57J		57K		57L		57M	
x	y	x	y	x	y	x	y
0.3294	0.3306	0.3294	0.3364	0.3293	0.3423	0.3293	0.3481
0.3294	0.3364	0.3293	0.3423	0.3293	0.3481	0.3292	0.3539
0.3331	0.3398	0.3332	0.3458	0.3333	0.3518	0.3334	0.3578
0.3330	0.3338	0.3331	0.3398	0.3332	0.3458	0.3333	0.3518

5700K ( CCT 5311 - 5468K )

57N		57O		57P		57Q	
x	y	x	y	x	y	x	y
0.3330	0.3338	0.3331	0.3398	0.3332	0.3458	0.3333	0.3518
0.3331	0.3398	0.3332	0.3458	0.3333	0.3518	0.3334	0.3578
0.3369	0.3431	0.3371	0.3493	0.3374	0.3554	0.3376	0.3616
0.3366	0.3369	0.3369	0.3431	0.3371	0.3493	0.3374	0.3554

## 6500K ( CCT 6749 - 7040K )

65A		65B		65C		65D	
x	y	x	y	x	y	x	y
0.3068	0.3113	0.3058	0.3161	0.3048	0.3209	0.3038	0.3256
0.3058	0.3161	0.3048	0.3209	0.3038	0.3256	0.3028	0.3304
0.3098	0.3200	0.3089	0.3249	0.3080	0.3299	0.3072	0.3349
0.3107	0.3150	0.3098	0.3200	0.3089	0.3249	0.3080	0.3299

## 6500K ( CCT 6485 - 6749K )

65E		65F		65G		65H	
x	y	x	y	x	y	x	y
0.3107	0.3150	0.3098	0.3200	0.3089	0.3249	0.3080	0.3299
0.3098	0.3200	0.3089	0.3249	0.3080	0.3299	0.3072	0.3349
0.3138	0.3239	0.3131	0.3290	0.3123	0.3342	0.3115	0.3393
0.3146	0.3187	0.3138	0.3239	0.3131	0.3290	0.3123	0.3342

## 6500K ( CCT 6243 - 6485K )

65J		65K		65L		65M	
x	y	x	y	x	y	x	y
0.3146	0.3187	0.3138	0.3239	0.3131	0.3290	0.3123	0.3342
0.3138	0.3239	0.3131	0.3290	0.3123	0.3342	0.3115	0.3393
0.3178	0.3277	0.3172	0.3331	0.3166	0.3384	0.3160	0.3437
0.3184	0.3224	0.3178	0.3277	0.3172	0.3331	0.3166	0.3384

## 6500K ( CCT 6020 - 6243K )

65N		65O		65P		65Q	
x	y	x	y	x	y	x	y
0.3184	0.3224	0.3178	0.3277	0.3172	0.3331	0.3166	0.3384
0.3178	0.3277	0.3172	0.3331	0.3166	0.3384	0.3160	0.3437
0.3217	0.3316	0.3213	0.3371	0.3209	0.3426	0.3205	0.3481
0.3221	0.3261	0.3217	0.3316	0.3213	0.3371	0.3209	0.3426



## 6. Color Spectrum

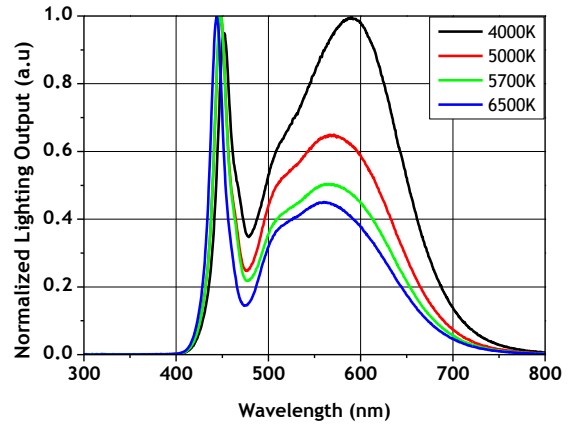
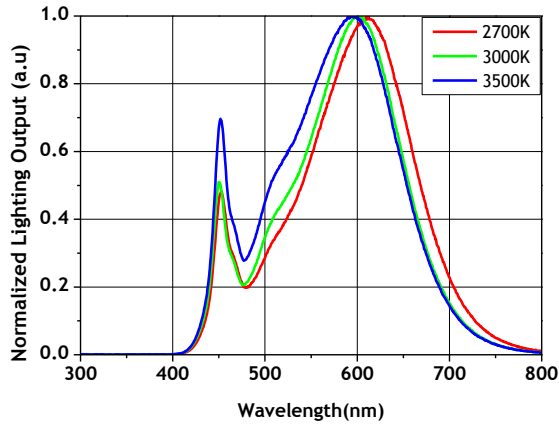

## 7. Characteristic Diagrams

(1) Forward Voltage vs Forward Current

(Ta = 25°C)

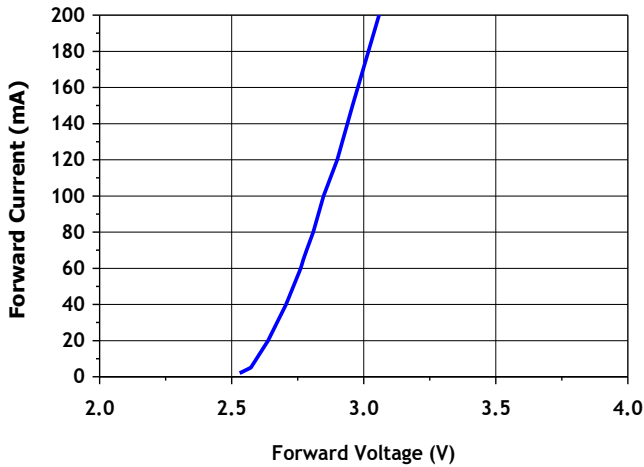

(2) Forward Current vs Relative L-Flux

(Ta = 25°C)

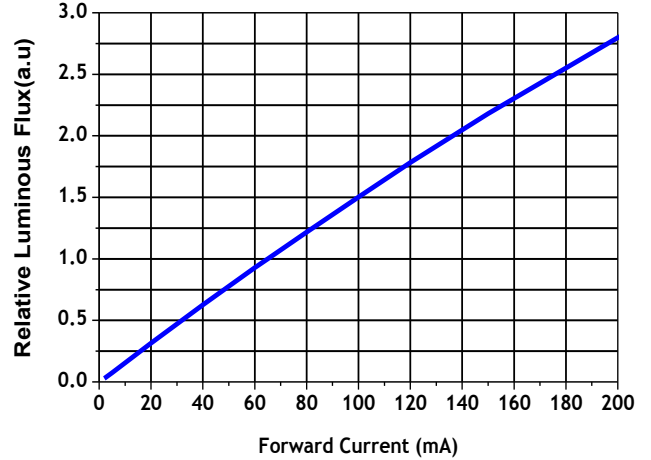

(3) View angle profile

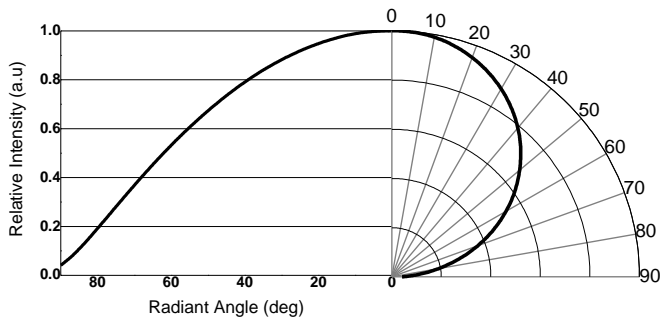

## 8. Reliability

### (1) Test items and results

NO	Test Item	Standard Test Method	Test Conditions	Note	Number of Damaged
1	Temperature Cycle	JEITA ED-4701 100 105	-40℃ ~ 25℃ ~ 100℃ ~ 25℃ 30min. 5min. 30min. 5min	100 cycles	0/20
2	High Temperature Storage	JEITA ED-4701 200 201	Ta=100℃	1000 hrs	0/20
3	Temperature Humidity Storage	JEITA ED-4701 100 103	Ta=85℃, RH=85%	1000 hrs	0/20
4	Low Temperature Storage	JEITA ED-4701 200 202	Ta=-40℃	1000 hrs	0/20
5	Steady State Operating Life	-	Ta=25℃, I <sub>F</sub> =150mA	1000 hrs	0/20
6	Steady State Operating Life of High Temperature	-	Ta=85℃, I <sub>F</sub> =150mA	1000 hrs	0/20
7	Steady State Operating Life of High Humidity Heat	-	Ta=85℃, RH=85%, I <sub>F</sub> =150mA	1000 hrs	0/20
8	Steady State Operating Life of Low Temperature	-	Ta=-40℃, I <sub>F</sub> =150mA	1000 hrs	0/20
9	Electro-Static Discharge Threshold	ESD (HBM)	1500Ω, 100pF	6000V	0/10

### (2) Criteria for judging the damage

ITEM	Symbol	Test Condition	Criteria for Judgement	
			Min.	Max.
Forward Voltage	V <sub>F</sub>	I <sub>F</sub> =150mA	-	USL *1 × 1.2
Luminous Intensity	I <sub>V</sub>	I <sub>F</sub> =150mA	LSL*2 × 0.7	

\*1) U.S.L. : Upper Standard Level    \*2) L.S.L : Lower Standard Level

## 9. Recommend soldering conditions

### (1) Recommend soldering conditions

Reflow Soldering		Hand Soldering(Lead Part)	
Pre-heat Pre-heat time Peak temperature Soldering Time Condition	Lead Free Solder	Temperature Soldering Time	Max. 340°C Max. 3sec (only one time)
	180~200°C 120sec. Max. Max. 260°C Max. 10sec		

### Temperature-profile

#### <Lead-free Solder>

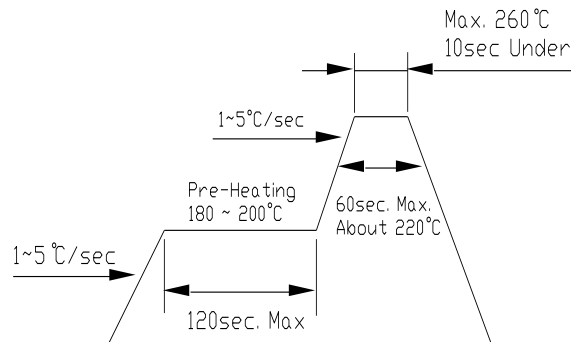

#### <Recommended soldering pad design>

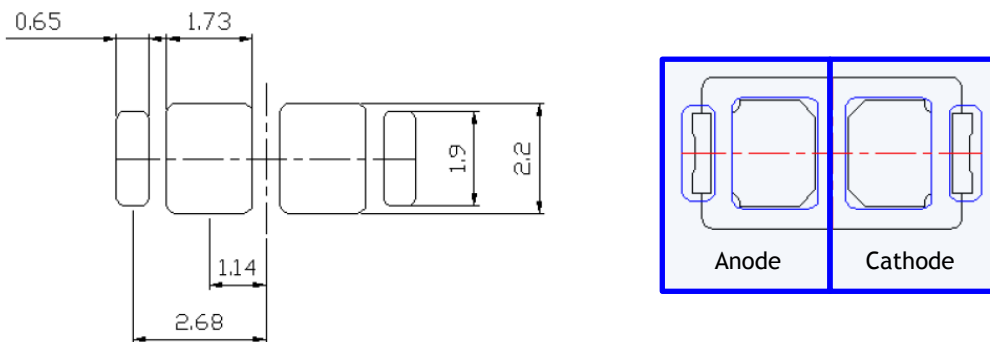

## (2) Moisture Proof Package

When moisture is absorbed into the SMT package it may vaporize and expand during soldering. There is a possibility that this can cause exfoliation of the contacts and damage to the optical characteristics of the LEDs. For this reason, the moisture proof package is used to keep moisture to a minimum in the package. The moisture proof package is made of an aluminum moisture proof bag. A package of a moisture absorbent material(silica gel) is inserted into the aluminum moisture proof bag. The silica gel changes its color from blue to pink as it absorbs moisture.

## (3)Storage

[Storage conditions]

Before opening the package

The LEDs should be kept at 30°C or less and 90% RH or less. The LEDs should be used within a year. When storing the LEDs, moisture proof packaging with absorbent material(silica gel) is recommended.

After opening the package

The LEDs should be kept at 30°C or less and 70% RH or less. The LEDs should be soldered within 168 hours(7days) after opening the package. If unused LEDs remain, they should be stored in moisture proof packages, such as sealed containers with package of moisture absorbent material(silica gel). It is also recommended to return the LEDs to the original moisture proof bag and to reseal the moisture proof bag again.If the moisture absorbent material(silica gel) has faded away or the LEDs have exceeded the storage time, baking treatment should be performed using the following conditions.

Baking treatment : more than 24hours at 65±5°C

LED part's electrodes and lead frames are silver plated copper alloy.

The silver surface may be affected by environments which contain corrosive substances.

Please avoid conditions which may cause the LED to corrode, tarnish or discolor.

The corrosion or discoloration might lower solderability or might affect on optical Characteristics.

Please avoid rapid transitions in ambient temperature, especially in high humidity environments where condensation can occur.

## (4)Heat Generation

Thermal design of the end product is of paramount importance. Please consider the heat generation of the LED when making the system design. The coefficient of temperature increase per input electric power is affected by the thermal resistance of the circuit board and density of LED placement on the board, as well as other components. It is necessary to avoid intense heat generation and operate within the maximum ratings given in the specification.

The operating current should be decided after considering the ambient maximum temperature of LEDs.

# 10. Packing

## (1) Taping part

unit : mm  
tolerance : ± 0.1

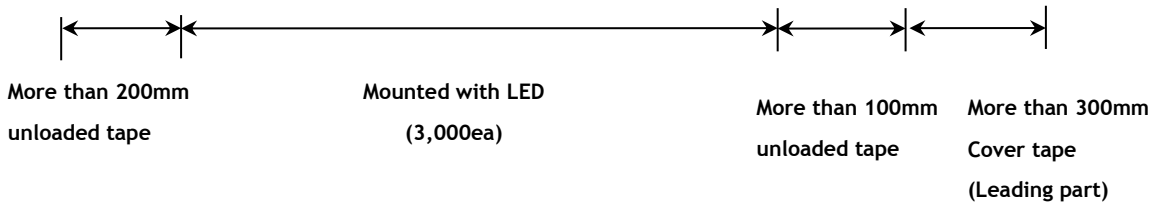
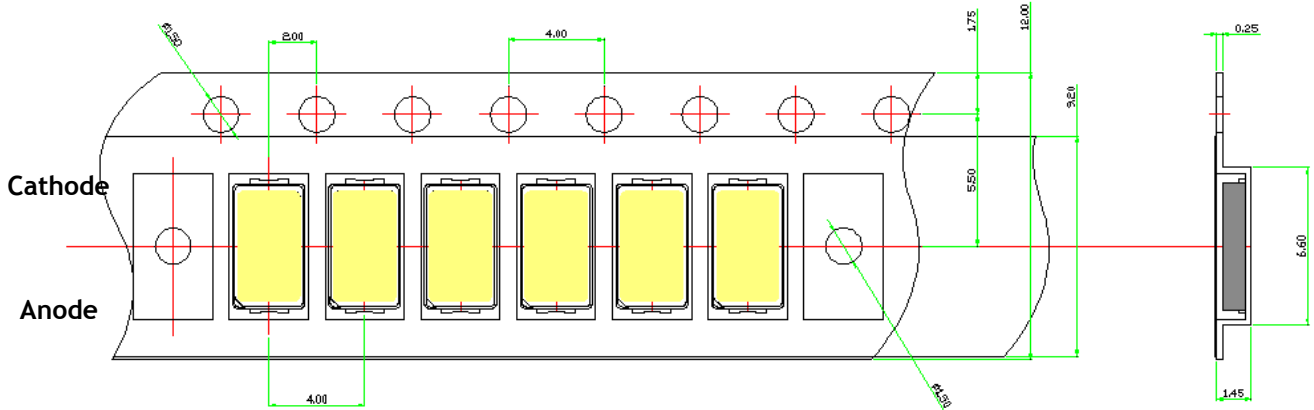

## (2) Reel part (Q'ty : Min. 500ea/Reel)

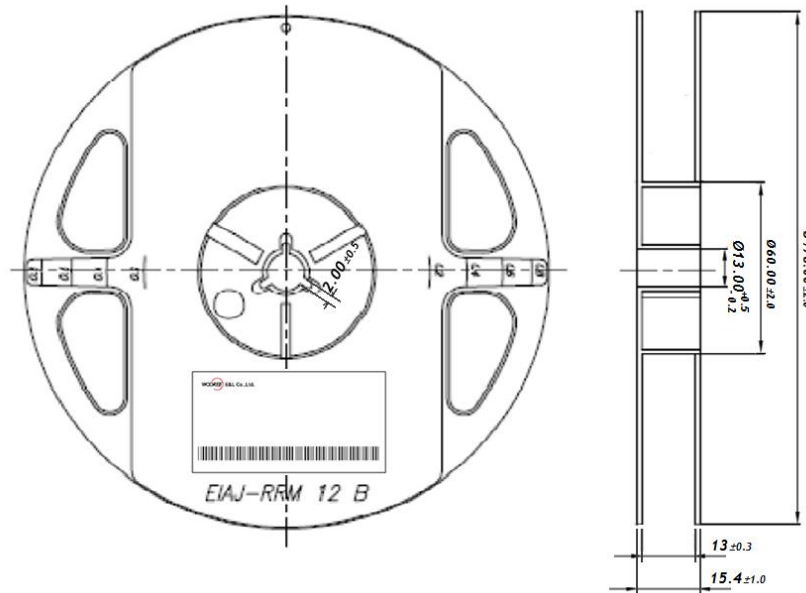

**(3) Boxing**

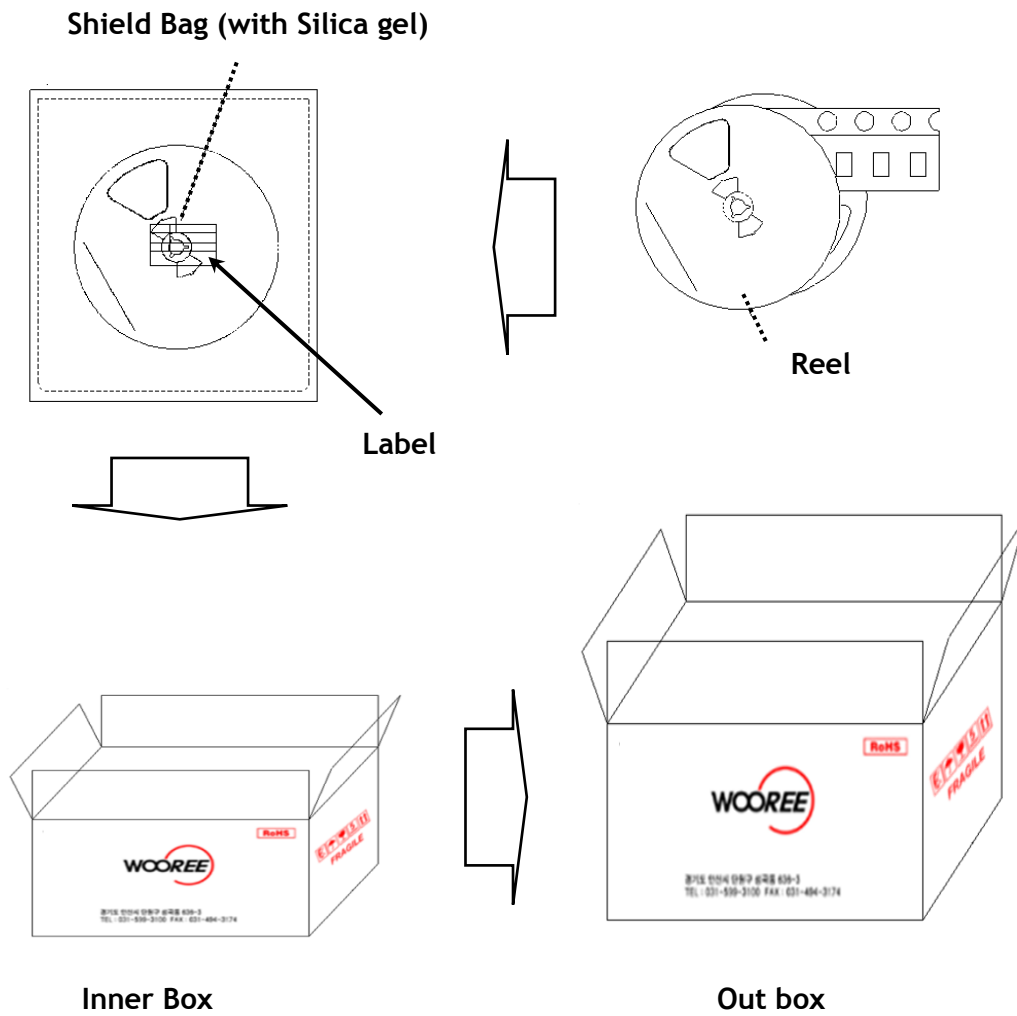

Box	Dimension (mm)	Reel/Box	Quantity/Box
Inner box	500*260*250	24 Reel max.	72,000 ea
Out box	555*515*540	96 Reel max.	288,000 ea

**(4) Label Information**

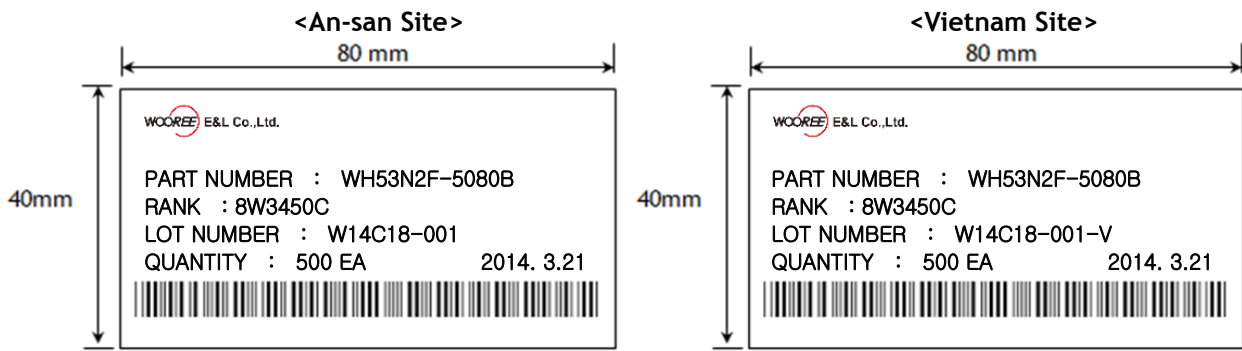

**(5) Lot Number**

**<An-san Site>**



- ① WOOREE E&L Initial
- ② Year (14 for 2014, 15 for 2015)
- ③ Month (A for Jan., B for Feb., ... , M for Dec.)
- ④ Day (01 for 1,....31 for 31)
- ⑤ WOOREE E&L Product Running Number

**<Vietnam Site>**

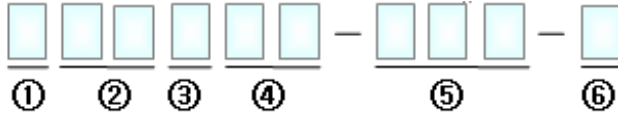

- ① WOOREE E&L Initial
- ② Year (14 for 2014, 15 for 2015)
- ③ Month (A for Jan., B for Feb., ... , M for Dec.)
- ④ Day (01 for 1,....31 for 31)
- ⑤ WOOREE E&L Product Running Number
- ⑥ WOOREE E&L Manufacturing Plant (V for Vietnam)

**(6) Rank Code description**

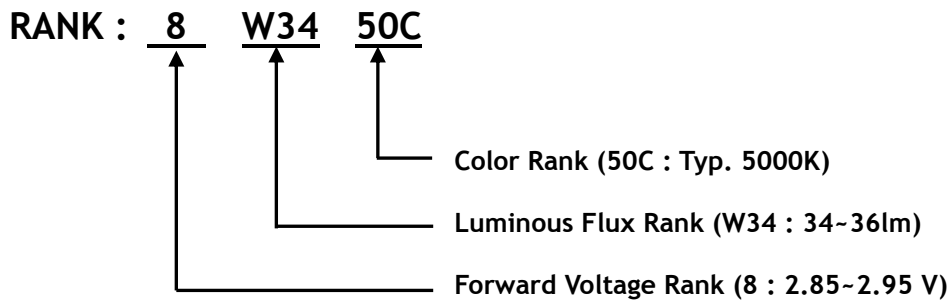

## 11. Revision History

Spec NO.			
Title	Specification for Approval		
Times	Date	Summary of revision	Remarks
1	2015. 01. 20	INITIAL ISSUE	R(0)
2	2015. 01. 23	Addition of Thermal Resistance	R(1)
3	2015. 01 .28	Change of L-Flux range	R(2)