

Customer :

Specification for Approval

Part Name : WL53N2F-xx70B

(Preliminary)

Customer : _____ 2014.

Checked	Checked	Approved	Remark
/	/	/	

WOOREE E&L Co., Ltd. 2014. 5. 9.

Designed	Checked	Approved
/	/	/

WOOREE E&L CO., LTD 636-3, Sunggok-dong, Danwon-gu, Ansan-si, Kyunggy-do, Korea.

Tel (031)599-3013 Fax (031)494-3174

 **WOOREE** E&L Co.,Ltd.

CONTENTS

1. Features
2. Outline Dimension
3. Absolute Maximum Ratings
4. Electrical / Optical Characteristics
5. Ranks
6. Color Spectrum
7. Characteristic Diagrams
8. Reliability
9. Recommend soldering conditions
10. Packing
11. Revision History

1. Features

- SMD Top View Type
- Long Time Reliability (with ESD Protection)
- Package size is 5.6 * 3.0* 0.9t (mm)
- Application : General Lighting

2. Outline Dimension

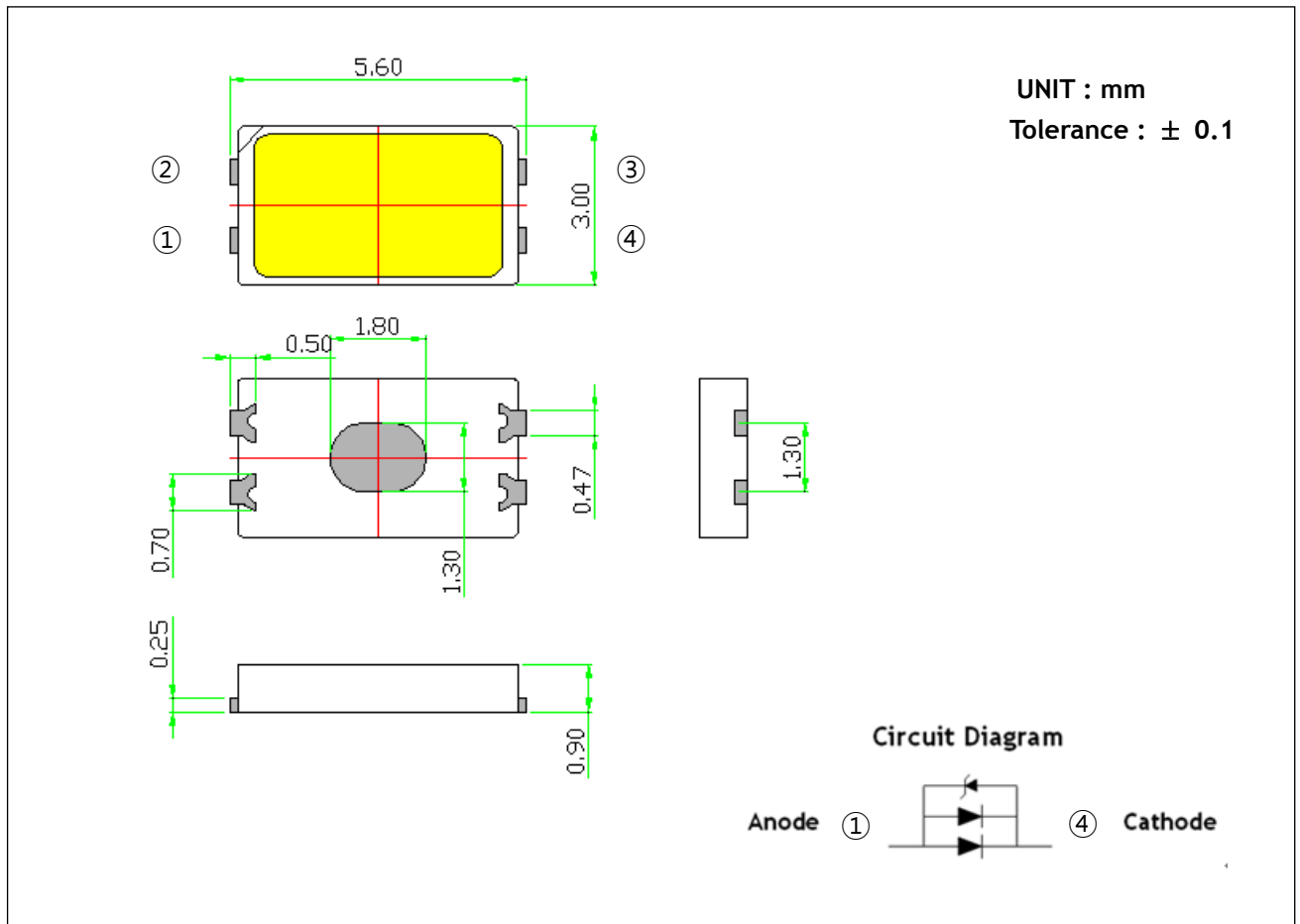

Part list

Parts No.	Name	Description
1	Chip source	Blue LED
2	Body	Thermo Plastic
3	Lead frame base	Metal
4	Phosphor	Yellow, Red color Emitting
5	Resin	Encapsulant

3. Absolute maximum ratings

Item	Symbol	Absolute Maximum Ratings	Unit
Forward Current	I_F	180	mA
Pulse Forward Current*1	I_{FP}	200	mA
Power Dissipation	P_D	0.5	W
Operating Temperature	T_{OPR}	-40 ~ +85	°C
Storage Temperature	T_S	-40 ~ +100	°C
Solder Temperature	T_{SLD}	Reflow 260 °C, 10sec under Hand 340 °C 3sec under	°C
Junction Temperature	T_J	100	°C

*1. Pulse Width ≤ 10msec, Duty ≤ 10%

4. Electrical/Optical characteristics

(Ta=25°C)

Item	Symbol	Condition	Value			Unit
			Min	Typ.	Max	
Forward Voltage *1	V_F	$I_F=150mA$	3.1	3.25	3.5	V
Luminous Flux*2	Φ_V	$I_F=150mA$	54.0	58.0	62.0	lm
Color Temperature *3 [CIE 1931 Coordinates]	CCT	$I_F=150mA$	4745	-	7040	K
Viewing Angle	$2\theta_{1/2}$	$I_F=150mA$	-	120	-	Deg.
Color Rendering Index	Ra	$I_F=150mA$	70	-	-	-

*1. Forward voltage measurement allowance is ±0.05V

*2. Luminous Flux measurement allowance is ±5%

*3. Color Temperature measurement allowance is ±100K

5. Ranks

(1) Forward Voltage

(Ta=25°C)

Rank	Condition	Min.	Max.	Unit
1	I _F = 150mA	3.1	3.2	V
2		3.2	3.3	
3		3.3	3.4	
4		3.4	3.5	

(2) Luminous Flux

(Ta=25°C)

Rank	Condition	CCT 5000K	CCT 5700K	CCT 6500K	Unit
W54	I _F = 150mA	54-56	54-56	54-56	lm
W56		56-58	56-58	56-58	
W58		58-60	58-60	58-60	
W60		60-62	60-62	60-62	

(3) Chromaticity coordinates $(I_F = 150\text{mA}, T_a = 25^\circ\text{C})$

50A		50B		50C		50D	
X	Y	X	Y	X	Y	X	Y
0.3366	0.3369	0.3369	0.3431	0.3371	0.3493	0.3374	0.3554
0.3369	0.3431	0.3371	0.3493	0.3374	0.3554	0.3376	0.3616
0.3407	0.3462	0.3411	0.3525	0.3415	0.3588	0.3420	0.3652
0.3403	0.3399	0.3407	0.3462	0.3411	0.3525	0.3415	0.3588
50E		50F		50G		50H	
X	Y	X	Y	X	Y	X	Y
0.3403	0.3399	0.3407	0.3462	0.3411	0.3525	0.3415	0.3588
0.3407	0.3462	0.3411	0.3525	0.3415	0.3588	0.3420	0.3652
0.3446	0.3493	0.3452	0.3558	0.3457	0.3622	0.3463	0.3687
0.3440	0.3428	0.3446	0.3493	0.3452	0.3558	0.3457	0.3622
50J		50K		50L		50M	
X	Y	X	Y	X	Y	X	Y
0.3440	0.3428	0.3446	0.3493	0.3452	0.3558	0.3457	0.3622
0.3446	0.3493	0.3452	0.3558	0.3457	0.3622	0.3463	0.3687
0.3485	0.3524	0.3492	0.3591	0.3500	0.3657	0.3507	0.3724
0.3477	0.3458	0.3485	0.3524	0.3492	0.3591	0.3500	0.3657
50N		50O		50P		50Q	
X	Y	X	Y	X	Y	X	Y
0.3477	0.3458	0.3485	0.3524	0.3492	0.3591	0.3500	0.3657
0.3485	0.3524	0.3492	0.3591	0.3500	0.3657	0.3507	0.3724
0.3523	0.3555	0.3533	0.3624	0.3542	0.3692	0.3551	0.3760
0.3514	0.3487	0.3523	0.3555	0.3533	0.3624	0.3542	0.3692

57A		57B		57C		57D	
X	Y	X	Y	X	Y	X	Y
0.3222	0.3243	0.3218	0.3298	0.3215	0.3353	0.3211	0.3407
0.3218	0.3298	0.3215	0.3353	0.3211	0.3407	0.3207	0.3462
0.3256	0.3331	0.3254	0.3388	0.3252	0.3444	0.3250	0.3501
0.3258	0.3275	0.3256	0.3331	0.3254	0.3388	0.3252	0.3444
57E		57F		57G		57H	
X	Y	X	Y	X	Y	X	Y
0.3258	0.3275	0.3256	0.3331	0.3254	0.3388	0.3252	0.3444
0.3256	0.3331	0.3254	0.3388	0.3252	0.3444	0.3250	0.3501
0.3294	0.3364	0.3293	0.3423	0.3293	0.3481	0.3292	0.3539
0.3294	0.3306	0.3294	0.3364	0.3293	0.3423	0.3293	0.3481
57J		57K		57L		57M	
X	Y	X	Y	X	Y	X	Y
0.3294	0.3306	0.3294	0.3364	0.3293	0.3423	0.3293	0.3481
0.3294	0.3364	0.3293	0.3423	0.3293	0.3481	0.3292	0.3539
0.3331	0.3398	0.3332	0.3458	0.3333	0.3518	0.3334	0.3578
0.3330	0.3338	0.3331	0.3398	0.3332	0.3458	0.3333	0.3518
57N		57O		57P		57Q	
X	Y	X	Y	X	Y	X	Y
0.3330	0.3338	0.3331	0.3398	0.3332	0.3458	0.3333	0.3518
0.3331	0.3398	0.3332	0.3458	0.3333	0.3518	0.3334	0.3578
0.3369	0.3431	0.3371	0.3493	0.3374	0.3554	0.3376	0.3616
0.3366	0.3369	0.3369	0.3431	0.3371	0.3493	0.3374	0.3554

65A		65B		65C		65D	
X	Y	X	Y	X	Y	X	Y
0.3068	0.3113	0.3058	0.3161	0.3048	0.3209	0.3038	0.3256
0.3058	0.3161	0.3048	0.3209	0.3038	0.3256	0.3028	0.3304
0.3098	0.3200	0.3089	0.3249	0.3080	0.3299	0.3072	0.3349
0.3107	0.3150	0.3098	0.3200	0.3089	0.3249	0.3080	0.3299
65E		65F		65G		65H	
X	Y	X	Y	X	Y	X	Y
0.3107	0.3150	0.3098	0.3200	0.3089	0.3249	0.3080	0.3299
0.3098	0.3200	0.3089	0.3249	0.3080	0.3299	0.3072	0.3349
0.3138	0.3239	0.3131	0.3290	0.3123	0.3342	0.3115	0.3393
0.3146	0.3187	0.3138	0.3239	0.3131	0.3290	0.3123	0.3342
65J		65K		65L		65M	
X	Y	X	Y	X	Y	X	Y
0.3146	0.3187	0.3138	0.3239	0.3131	0.3290	0.3123	0.3342
0.3138	0.3239	0.3131	0.3290	0.3123	0.3342	0.3115	0.3393
0.3178	0.3277	0.3172	0.3331	0.3166	0.3384	0.3160	0.3437
0.3184	0.3224	0.3178	0.3277	0.3172	0.3331	0.3166	0.3384
65N		65O		65P		65Q	
X	Y	X	Y	X	Y	X	Y
0.3184	0.3224	0.3178	0.3277	0.3172	0.3331	0.3166	0.3384
0.3178	0.3277	0.3172	0.3331	0.3166	0.3384	0.3160	0.3437
0.3217	0.3316	0.3213	0.3371	0.3209	0.3426	0.3205	0.3481
0.3221	0.3261	0.3217	0.3316	0.3213	0.3371	0.3209	0.3426

(4) Chromaticity Coordinates Diagram

($I_F=150\text{mA}$, $T_a=25^\circ\text{C}$)

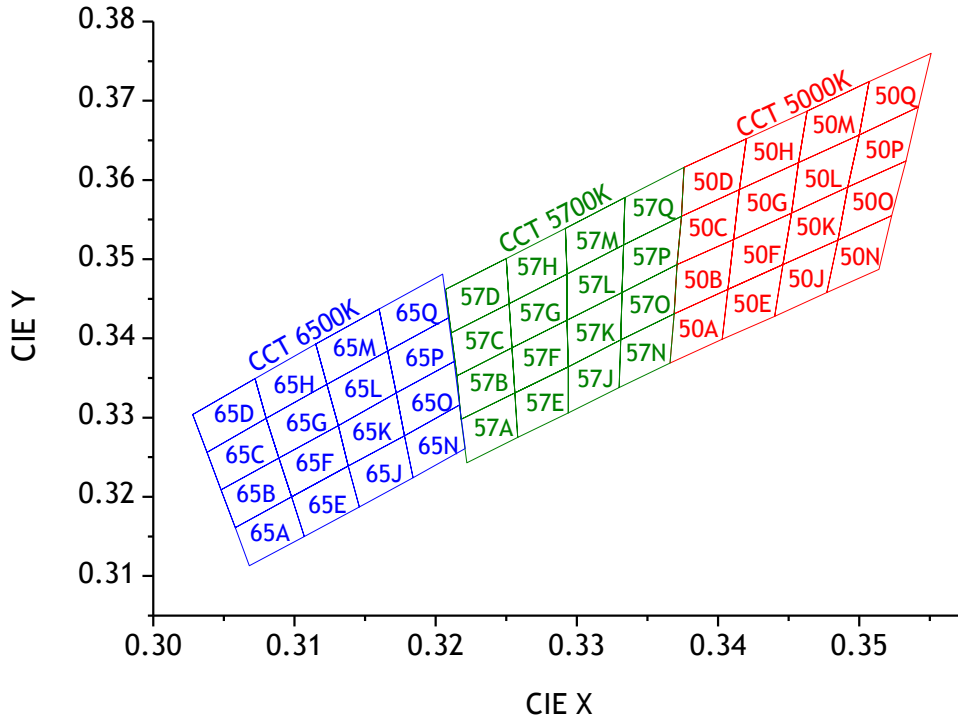

6. Color Spectrum

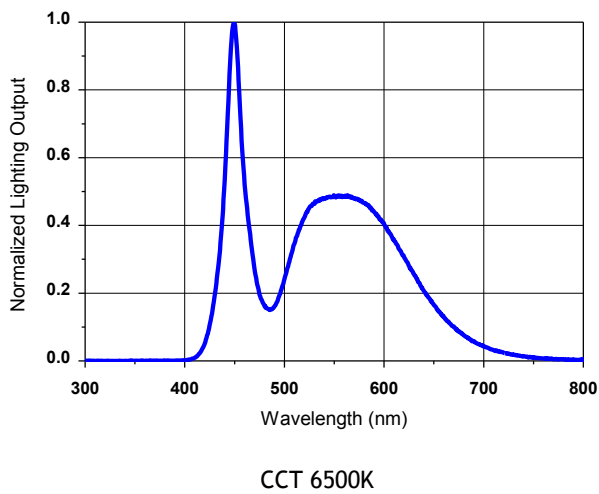

7. Characteristic Diagrams

(1) Forward Voltage vs Forward Current

(Ta = 25°C)

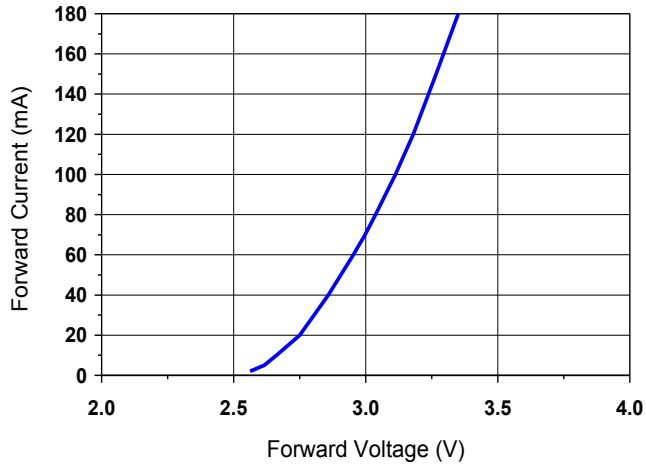

(2) Forward Current vs Relative L-Flux

(Ta = 25°C)

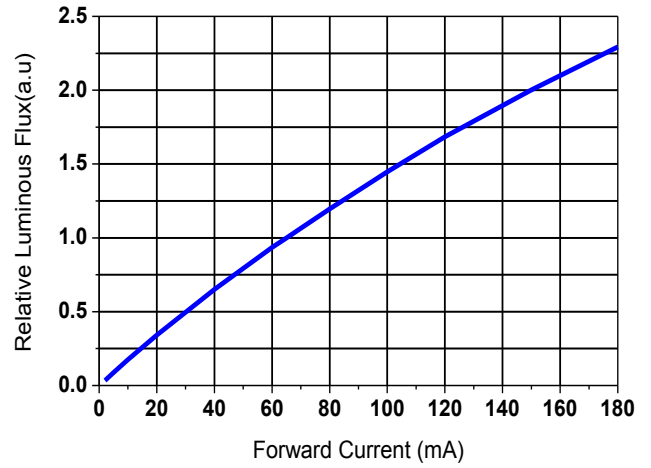

(3) View angle profile

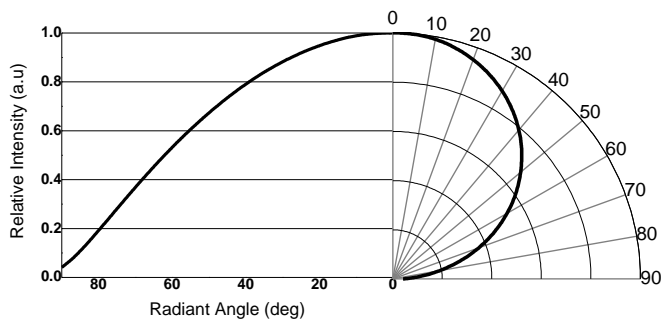

8. Reliability

(1) Test items and results

NO	Test Item	Standard Test Method	Test Conditions	Note	Number of Damaged
1	Temperature Cycle	JEITA ED-4701 100 105	-40℃ ~ 25℃ ~ 100℃ ~ 25℃ 30min. 5min. 30min. 5min	100 cycles	0/20
2	High Temperature Storage	JEITA ED-4701 200 201	Ta=100℃	1000 hrs	0/20
3	Temperature Humidity Storage	JEITA ED-4701 100 103	Ta=85℃, RH=85%	1000 hrs	0/20
4	Low Temperature Storage	JEITA ED-4701 200 202	Ta=-40℃	1000 hrs	0/20
5	Steady State Operating Life	-	Ta=25℃, I _F =150mA	1000 hrs	0/20
6	Steady State Operating Life of High Temperature	-	Ta=85℃, I _F =150mA	1000 hrs	0/20
7	Steady State Operating Life of High Humidity Heat	-	Ta=85℃, RH=85%, I _F =150mA	1000 hrs	0/20
8	Steady State Operating Life of Low Temperature	-	Ta=-40℃, I _F =150mA	1000 hrs	0/20
9	Electro-Static Discharge Threshold	ESD (HBM)	1500Ω, 100pF (Forward/Reverse)	6000V	0/10

(2) Criteria for judging the damage

ITEM	Symbol	Test Condition	Criteria for Judgement	
			Min.	Max.
Forward Voltage	V _F	I _F =150mA	-	USL *1 × 1.2
Luminous Intensity	I _V	I _F =150mA	LSL*2 × 0.7	

*1) U.S.L. : Upper Standard Level *2) L.S.L : Lower Standard Level

9. Recommend soldering conditions

(1) Recommend soldering conditions

Reflow Soldering		Hand Soldering(Lead Part)	
	Lead Free Solder		
Pre-heat	180~200℃	Temperature Soldering Time	Max. 340℃ Max. 3sec (only one time)
Pre-heat time	120sec. Max.		
Peak temperature	Max. 260℃		
Soldering Time	Max. 10sec		
Condition			

Temperature-profile

<Lead-free Solder>

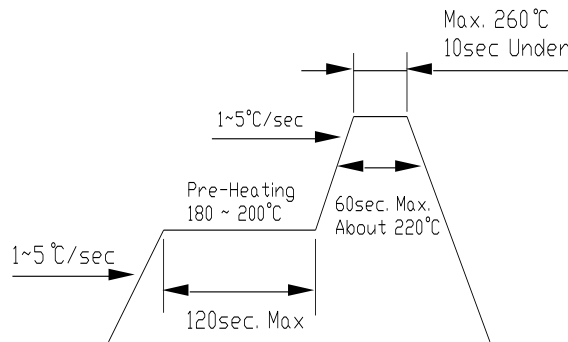

<Recommended soldering pad design>

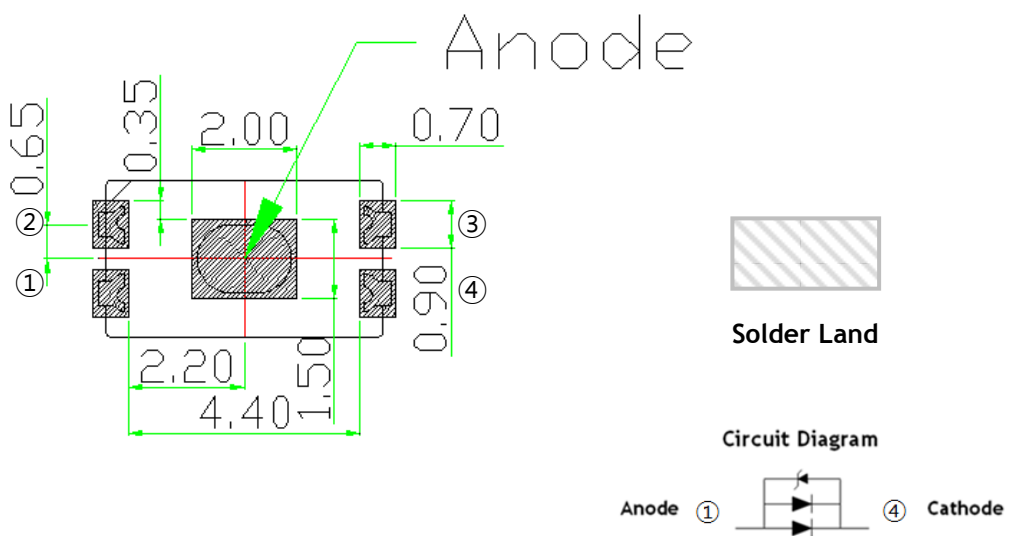

(2) Moisture Proof Package

When moisture is absorbed into the SMT package it may vaporize and expand during soldering. There is a possibility that this can cause exfoliation of the contacts and damage to the optical characteristics of the LEDs. For this reason, the moisture proof package is used to keep moisture to a minimum in the package. The moisture proof package is made of an aluminum moisture proof bag. A package of a moisture absorbent material(silica gel) is inserted into the aluminum moisture proof bag. The silica gel changes its color from blue to pink as it absorbs moisture.

(3)Storage

[Storage conditions]

Before opening the package

The LEDs should be kept at 30°C or less and 90% RH or less. The LEDs should be used within a year. When storing the LEDs, moisture proof packaging with absorbent material(silica gel) is recommended.

After opening the package

The LEDs should be kept at 30°C or less and 70% RH or less. The LEDs should be soldered within 168 hours(7days) after opening the package. If unused LEDs remain, they should be stored in moisture proof packages, such as sealed containers with package of moisture absorbent material(silica gel). It is also recommended to return the LEDs to the original moisture proof bag and to reseal the moisture proof bag again.If the moisture absorbent material(silica gel) has faded away or the LEDs have exceeded the storage time, baking treatment should be performed using the following conditions.

Baking treatment : more than 24hours at 65±5°C

LED part's electrodes and lead frames are silver plated copper alloy.

The silver surface may be affected by environments which contain corrosive substances.

Please avoid conditions which may cause the LED to corrode, tarnish or discolor.

The corrosion or discoloration might lower solderability or might affect on optical Characteristics.

Please avoid rapid transitions in ambient temperature, especially in high humidity environments where condensation can occur.

(4)Heat Generation

Thermal design of the end product is of paramount importance. Please consider the heat generation of the LED when making the system design. The coefficient of temperature increase per input electric power is affected by the thermal resistance of the circuit board and density of LED placement on the board, as well as other components. It is necessary to avoid intense heat generation and operate within the maximum ratings given in the specification.

The operating current should be decided after considering the ambient maximum temperature of LEDs.

10. Packing

(1) Taping part

unit : mm
tolerance : ± 0.1

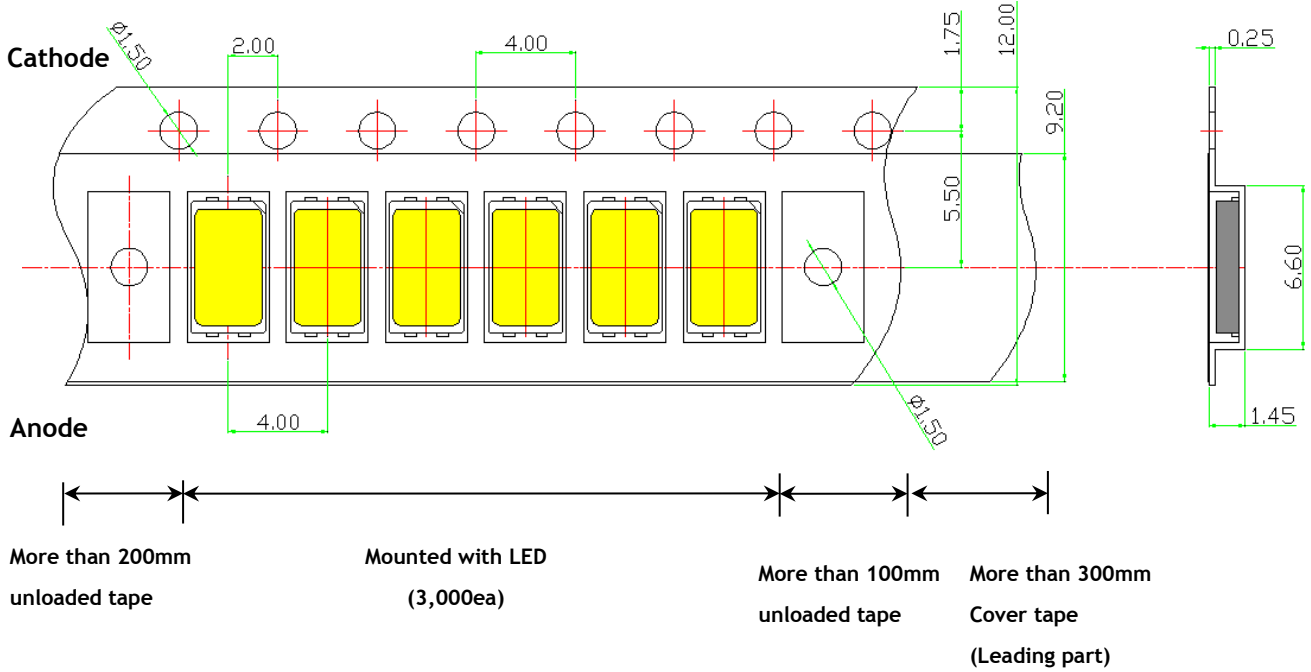

(2) Reel part (Q'ty : 3,000ea/Reel)

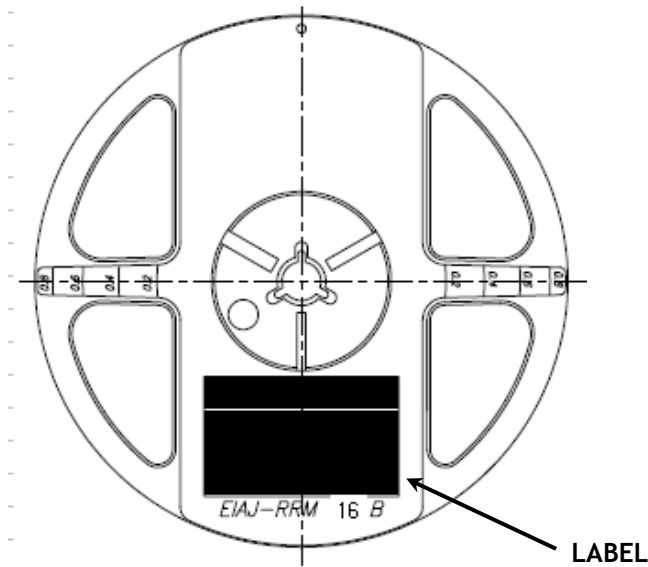

(3) Boxing

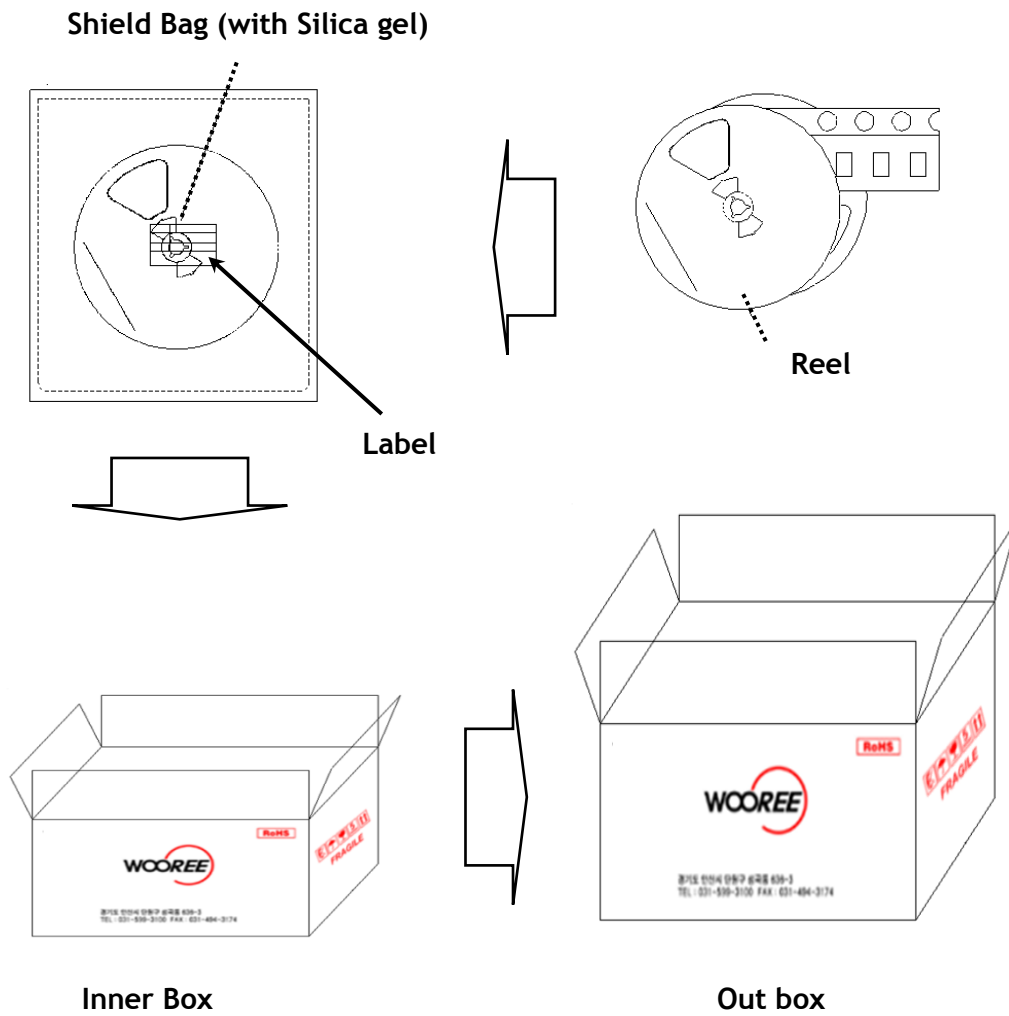

Box	Dimension (mm)	Reel/Box	Quantity/Box
Inner box	500*260*250	24 Reel max.	72,000 ea
Out box	555*515*540	96 Reel max.	288,000 ea

(4) Label Information

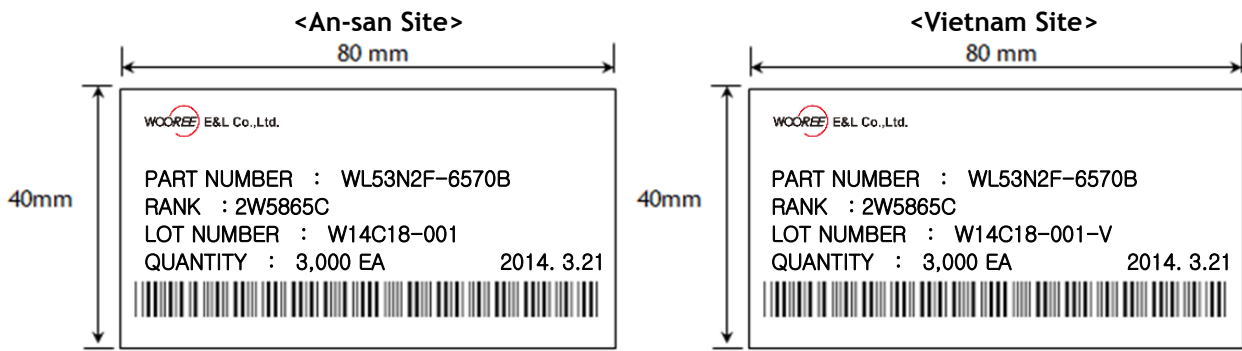

(5) Lot Number

<An-san Site>



- ① WOOREE E&L Initial
- ② Year (13 for 2013, 14 for 2014)
- ③ Month (A for Jan., B for Feb., ... , M for Dec.)
- ④ Day (01 for 1,....31 for 31)
- ⑤ WOOREE LED Product Running Number

<Yangzhou Site>

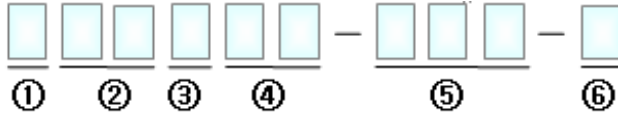

- ① WOOREE E&L Initial
- ② Year (13 for 2013, 14 for 2014)
- ③ Month (A for Jan., B for Feb., ... , M for Dec.)
- ④ Day (01 for 1,....31 for 31)
- ⑤ WOOREE LED Product Running Number
- ⑥ WOOREE LED Manufacturing Plant (V for Vietnam)

(6) Rank Code description

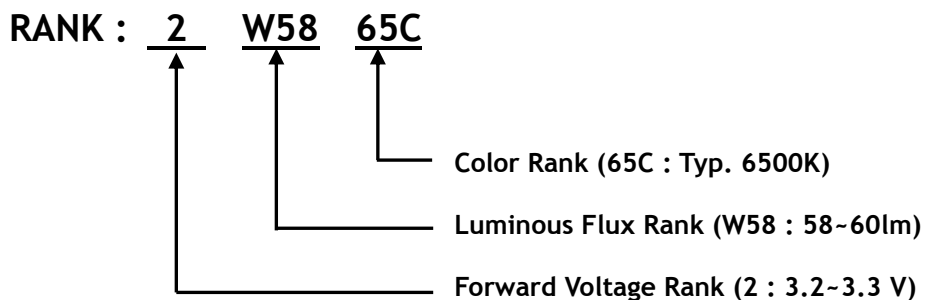

11. Revision History

Spec NO.			
Title	Specification for Approval		
Times	Date	Summary of revision	Remarks
1	2014. 04. 03	INITIAL ISSUE	R(0)